

04/2020, V12.01J

Instruction Manual

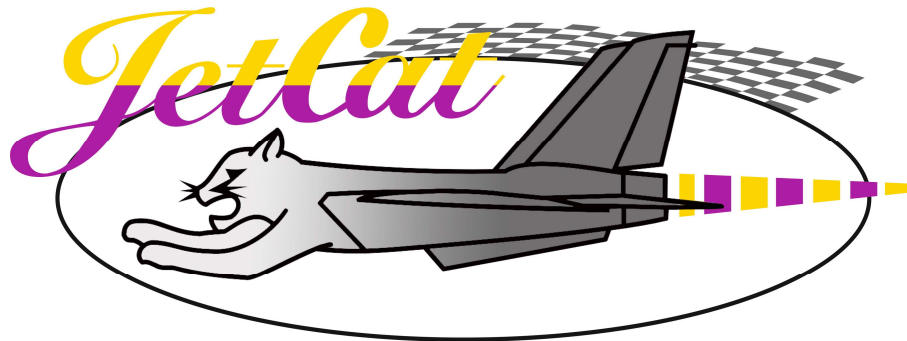

EZ-Fuelstation

Item. No.: 61105-63

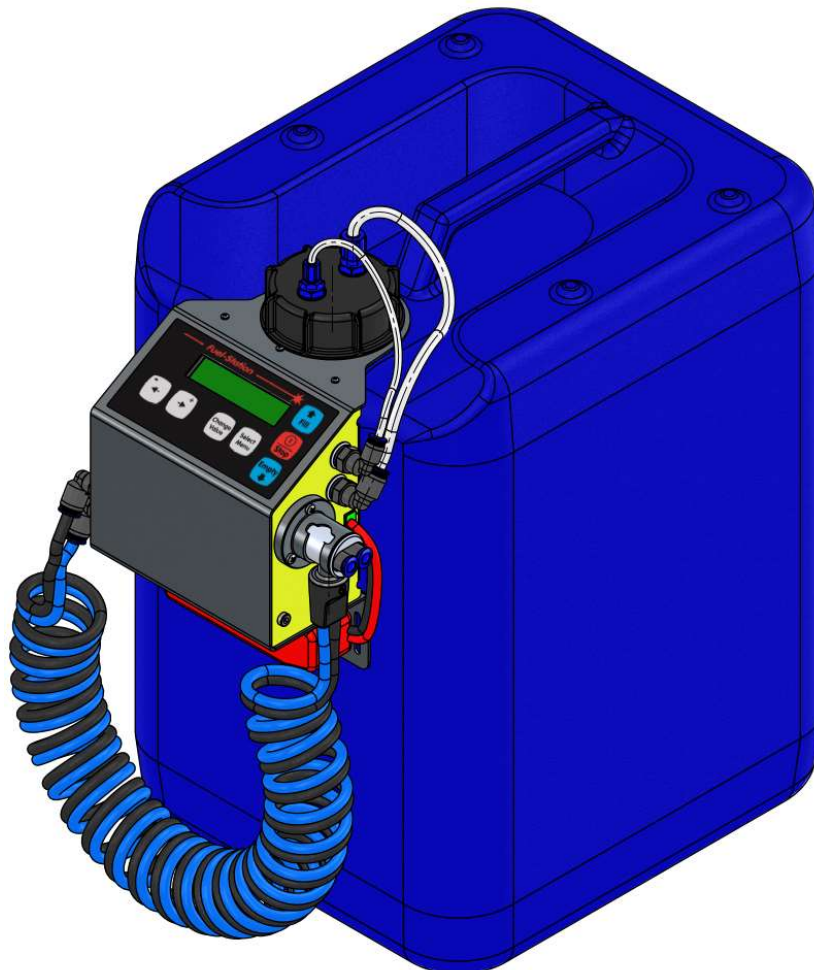





Contents

SAFETY INSTRUCTIONS, MEANING OF THE SYMBOLS	3
EZ-FUELSTATION DESCRIPTION	4
MOUNTING THE FUEL STATION ON THE JERRY CAN	6
CONNECTIONS	7
CONNECTIONS ON THE FUEL STATION	7
THE FUELDOCK CONNECTION	8
PRINCIPLE OF OPERATION	9
INTERNAL CONNECTION DIAGRAM.....	9
FUEL FEED:.....	9
FUEL RETURN/OVERFLOW:	9
"Tank Full" Detection Functionality	10
SAFETY FEATURES	11
OVERPRESSURE IN THE TANK.....	11
FILL-LINE DISCONNECTED	11
FUEL TANK EMPTY	11
FUEL TANK OVERFLOW	11
CONNECTION DIAGRAM FOR MODEL TANK SYSTEMS	12
A) REFUELING OF A "NORMAL" TANK SYSTEM WITH FLOWBACK LINE.....	12
A1) Connection diagram for refueling a "normal" tank system without EZ-Fueler filling valve	13
A2) Connection diagram for refueling a "normal" tank system with the EZ-Fueler filling valve	14
B) CONNECTION DIAGRAM, REFUELING WITH ONLY ONE FILLING LINE (WITHOUT FLOWBACK LINE)	17
B1) Connection diagram for single bag tanks.....	17
B2) Connection diagram for multiple bag tanks.....	18
B3) Refueling of single normal tanks without flowback line.....	19
CONTROL PANEL	20
OVERVIEW OF THE CONTROL KEYS.....	20
COMMISSIONING/SWITCHING ON	21
POWER SUPPLY	21
SWITCHING ON/OFF.....	21
OPERATING CONCEPT	22
Menu structure	23
Run menu.....	24
Select model/filling program	24
Explanation of the Run menu display	26
Fill-Settings menu	27
System-Settings menu	30
Statistics menu	34
TABLES WITH KEY COMMANDS	34
Key commands, filling functions	35
Key commands, special functions	36
QUICK START GUIDE	37
1) SELECTING A NEW MODEL AND NAMING IT	37
2) DEFINING REFUELING SETTINGS	37

3) SELECTING MODEL AND START FUELING PROCESS	37
RESETTING THE CONTAINER VOLUME	38
CHANGING THE MODEL NAME (FILL PROGRAM NAME)	39
CHANGING THE CONTAINER NAME.....	40
SERVICE FUNCTIONS	41
RESETTING THE VALUES OF THE STATISTICS MENU	41
RESETTING THE SYSTEM TO FACTORY SETTINGS	41
CALIBRATING THE FLOW METER.....	42
FIRMWARE UPDATE	49
ACCESSORIES.....	50

Safety instructions, meaning of the symbols

	<p>Attention! This symbol highlights the following instructions, which must be observed by the user! Any disregard of the information given here may affect the safe functioning of the device as well as the safety of the user.</p>
	<p>Attention! This symbol emphasizes prohibitions, which must be strictly observed by the user! Any disregard of the prohibitions on the right can significantly impair the functionality as well as the safety of the user.</p>
	<p>This symbol highlights instructions that should be strictly observed by the user to ensure safe operation of the device.</p>
	<p>Attention! Fire or explosion hazard!</p>

EZ-Fuelstation description

- Fully automatic filling or emptying of the model fuel tanks.
For this purpose, only a single key is required, the entire refueling/emptying process is then fully automatic! At the end of the refueling process, the pump always switches off automatically.
- Integrated flow meter for precise measurement/indication of filled or emptied volume.
At the end of the refueling/emptying process, the refueled or defueled volume in ml, as well as the refueling time are always displayed. If the fuel station has switched itself off after refueling (after an adjustable inactivity time), the last refueled quantity/action will be displayed at the next switch on!
- Optical flow rate detectors for the detection of fuel flow/presence on refueling and fuel return/overflow!
- Intelligent "tank full" detection via the optical detectors on the fuel flowback line and/or the integrated flow meter if only a single refueling hose without flowback line is used (change of volume flow).
- Provides a hermetically sealed, fully automatic refueling process that eliminates the possibility of fuel from the model entering the soil/environment, as the fuel overflow can be returned to the fuel station. Ideally in conjunction with the "EZ-Fueler" tank filling valve. Otherwise, the return hose can also be connected to the tank overflow.
- Automatic switch off when fuel containers are empty or when the fuel container overflows (e.g. when defueling large quantities into an almost full jerry can)
- Automatic shut-off when the refueling hose unintentionally "falls off"/disconnects during filling.
- Protective system to prevent fuel tank bursting if the tank overflow/vent has unintentionally not been opened.
- Display of the residual fuel volume in the fuel container
- Suitable for all conceivable model tank systems, in particular also for bag tanks with automatic venting of the bag tank, as well as automatic or adjustable decompression of the tank system at the end of the refueling process.
- Automatic shutdown when the system has not been used for a programmable time (auto power down, time adjustable).
- Automatic power-off when the battery is empty (battery protection function).
- Statistics menu for displaying: number of refueling operations, total volume conveyed, etc.
- Calibration option of the internal flow meter by the user.
- 2-line backlit LCD screen, membrane keypad with 7 keys.
- MPX input for 8-18V battery (recommended: 3S LiPo); battery is attached under the fuel station with Velcro®. Battery type adjustable.
- Data connector for free firmware updates via the Internet

- Freely programmable system, with 20 model memories (=filling programs). For each memory, the tank system can be individually programmed/preset e.g.:

Model name (plain text)

-Type of fuel tank ("normal" tank or bag tank)

-Refueling speed (pump capacity)

-Drawback volume at the end of the refueling process

-Optional "defueling volume" (to remove/lighten by a defined volume after the tank has been completely filled)

-Decompression factor in bag tanks (defines how "plump" the bag tank should be filled)

-Maximum or dosing volume (safety shutdown)

-Use of fuel flowback line on/off (1 or 2-hose mode)

- Different filling methods/algorithms selectable:

- **"Normal tank"** (automatic filling program)

Optimized filling algorithm for any combination of several series-connected "normal" tanks. Filling is ideally carried out with a filling line and a flowback line to the fuel container. The flowback line guarantees certain "tank full" detection every time.

However, it is also possible to fill with only one line without a flowback line. In this case, "tank full" detection occurs as soon as fuel flows into the overflow (→Detection of the flow loss in the tank system)!

- **"Bladder tank"** (automatic filling program)

Special filling algorithm for bag tanks which are refueled with only one filling line. Intelligent "tank full" detection and automatic decompression of the bag tank. Air bubbles are automatically detected and removed if necessary by repeated drawback.

- **"Dosing mode"** for defined filling or emptying of an adjustable quantity.

This mode can also be used, for example, for the targeted dosing/filling of programmable quantities.

- **"Manual mode with auto-stop"**, the pump starts directly in forward or reverse. If a "tank full" signal is detected by the integrated sensors, the pump stops automatically. Likewise, the pump automatically stops when the tank is empty (→ no more fuel flow)

- **"Manual mode without auto-stop"**

Pump runs forwards or backwards in continuous operation until the stop key is pressed.

- For all automatic filling programs, a programmable quantity (ml) can optionally be taken from the tank at the end of the refueling process. For example, to reduce/adjust the total weight of the model.

- Two rotatable Festo L quick connectors for fuel inlet/venting as well as refueling outlet and return flow.
- Suitable for all common fuels/smoke oil.
- Replaceable adapters for various fuel tanks.

Mounting the fuel station on the jerry can

Depending on the fuel container used, different jerry can mounting brackets can be attached to the fuel station.

The scope of delivery includes interchangeable adapters for fuel jerry cans with nominal diameters of 61 and 71mm.

The 71mm adapter is suitable for "short" fuel containers.

The 61mm adapter for the "tall" 20L fuel containers.

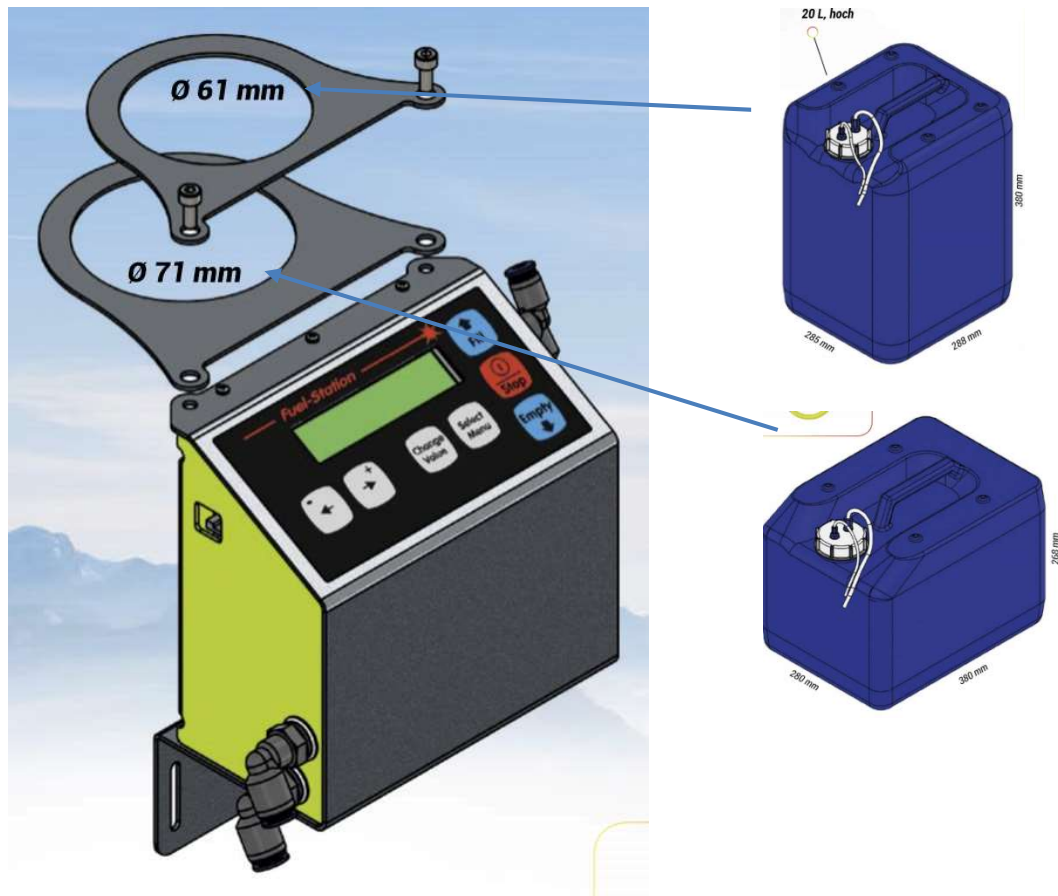

Connections

Connections on the fuel station

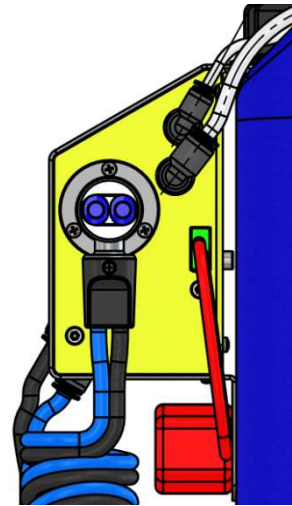
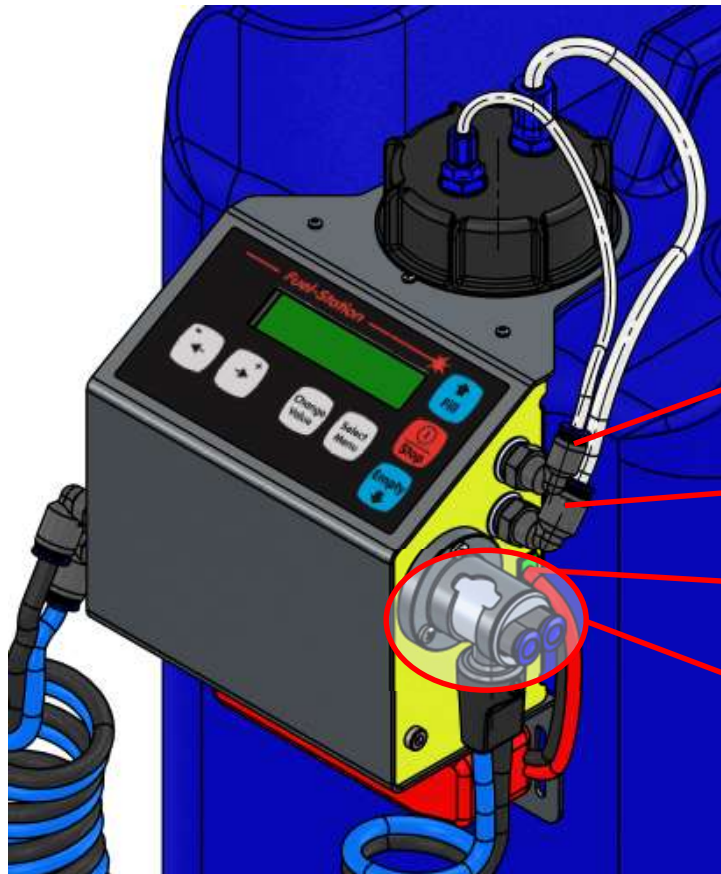

Fuel return
4mm hose

Fuel inlet
6mm hose

Battery input socket,
+ terminal is on top!

FuelDock
(see the next page)

Expansion socket
(e.g. for updates)

Fuel return (B), above,
black hose
(for 6mm hose)

Fuel outlet (A), below, blue
hose
(for 6mm hose)

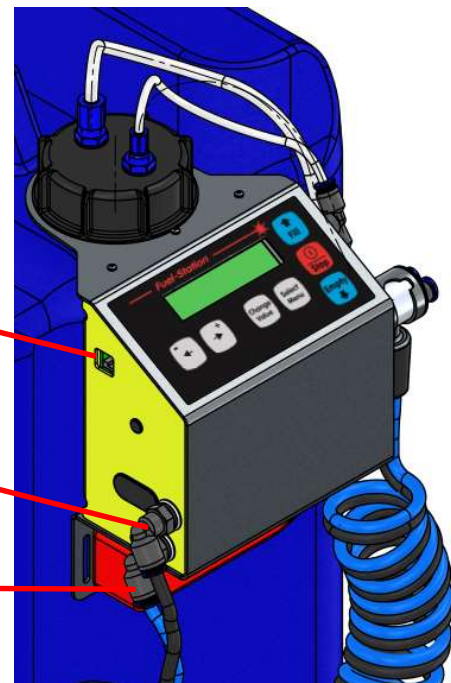

The FuelDock connection

The optional FuelDock connection, which can be mounted on the right side of the fuel station, has several functions:

It serves as a "park" and storage position for the "EZ-Fueler" filling connector. With the "EZ-Fueler" plug-in connector plugged in, the fuel fill hose is connected to outlet A, the fuel flowback line is connected to inlet B.

This allows several configurations/functions:

- 1) If no second/alternative fuel filling hose is to be used, then the two Festo connections A & B are simply "shorted" with a short length of hose. This has the consequence that the system is hermetically sealed as soon as the EZ-Fueler filling connector is hooked into the FuelDock (e.g. for transport).
- 2) Alternatively, another/alternative filling hose can be connected to outlet A (e.g. with a different/conventional hose coupling). Inlet B can then optionally be connected to the model's fuel overflow with another hose. For transport, the filling hose is then connected to the return hose, so that the system is again hermetically sealed! If refueling with the EZ-Fueler system, simply remove the EZ-Fueler fueling connector from the FuelDock for refueling. An additional fuel hose connected to the expansion port remains unaffected.

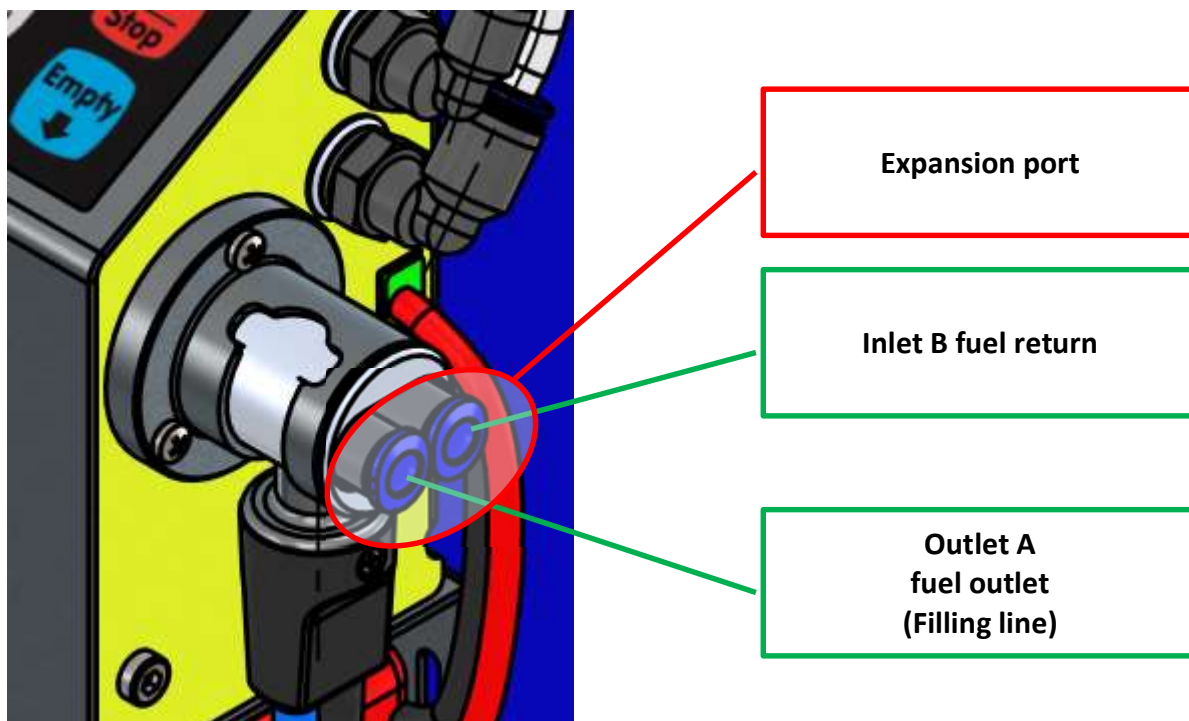

Principle of operation

Internal connection diagram

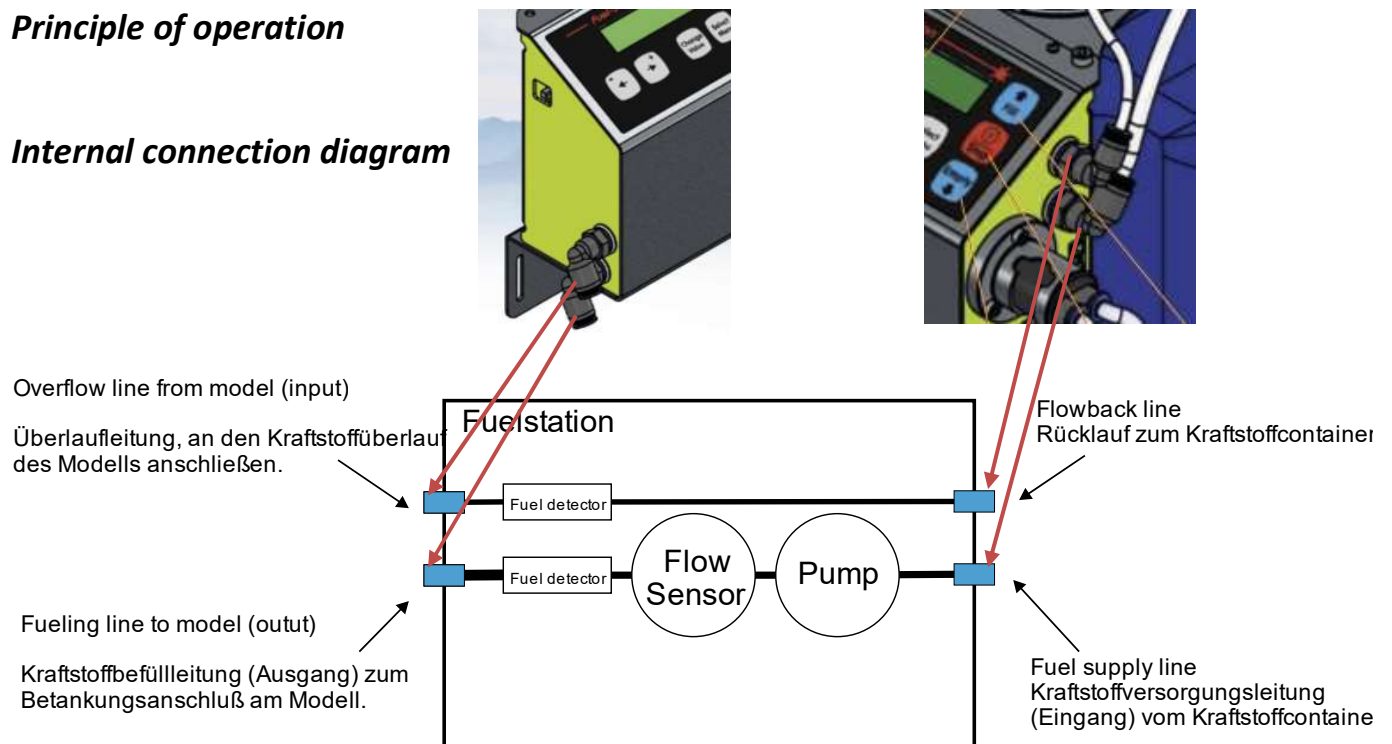

Fuel feed:

The fuel coming from the fuel container is first conducted to the pump inlet.

From the pump outlet, it then goes to the integrated flow meter for balancing the volume delivered, as well as for calculating the flow rate.

There is a detector immediately before the fuel outlet (connection point of the external refueling hose) which can detect the presence of fuel in the supply hose. The detector can distinguish whether there is bubble-free fuel, a fuel/air mixture or only air or is being conveyed in the hose.

Fuel return/overflow:

The fuel overflow coming from the model is connected to the return inlet of the fuel station. In the fuel station, this hose then also passes through a detector for detecting fuel or air bubbles in the return hose. Subsequently, this line is then connected to the vent of the actual fuel container.

"Tank full" detection functionality

"Tank full" detection takes place via two different operating principles:

- A) Fuel returns in the overflow pipe, through the fuel station and then back into the fuel container. As soon as the detector detects fuel in the flowback line, this is a sign that the tank is full.

This setting applies when the Stop-Signal parameter is set to 2-line flowback.
This option is not available for bag tanks as they do not use flowback lines.

- B) The second detection principle for "tank full" does not use the signal on the fuel flowback line, but only the fuel flow rate is evaluated.

With bag tanks, as soon as the tank becomes full, the pressure rises slightly. This has the consequence that the fuel flow drops slightly.

In a normal tank, the same happens as soon as fuel flows into the tank overflow line. Here, too, the pressure in the tank rises slightly, causing the fuel flow to drop slightly.

The fuel station software evaluates the fuel flow with appropriate algorithms and can derive the "tank full" signal from it.

The evaluation is not based on the absolute flow, but on its relative change.

This setting applies when the Stop-Signal parameter is set to "Flow/Pressure".

This option is automatically enabled for bag tanks.

The type of "tank full" detection assigned to the model memory can be set in the Fill-Settings menu (Page: 27 → Parameter: "Stop-Signal").

Safety features

The fuel station has various safety features that try to intercept typical operating errors. In practice, the possible errors that occur are:

Overpressure in the tank

Forgetting at the beginning of refueling to remove the plug from the tank overflow.

Incorrectly refueling a model with bag tank with a program that has set the flowback line as a "tank full" signal.

In these cases, the flow during refueling will drop unusually quickly. This circumstance is evaluated by the system and can be used for shutdown. The sensitivity of this monitoring function is set via the Burst Protection parameter in System-Settings.

If this monitoring function is triggered, the following is displayed in the upper line:

```
Overpressure!
```

Fill-line disconnected

A refueling process is under way and the refueling hose unintentionally separates from the refueling connection or a tank bursts. These circumstances lead to a sudden, unusual increase in the flow, which can be utilized to end the refueling process. In this case, the pump stops and the display shows:

```
Fill-line  
disconnected!
```

This monitoring function can be switched on/off via the Burst Protection parameter in System-Settings.

Fuel tank empty

If, during refueling, air is permanently detected in the refueling hose and no flow can be detected, the system terminates the refueling process with the message:

```
Container empty!  
-> STOPPED!
```

Fuel tank overflow

If fuel is detected on the return flow sensor for at least a certain amount of time during defueling, this normally means that the jerry can is completely full and that, instead of air, fuel is leaving the overflow. In this case, the system ends the defueling process with the message:

```
Container full!  
-> STOPPED!
```

Connection diagram for model tank systems

A) Refueling of a "normal" tank system with flowback line

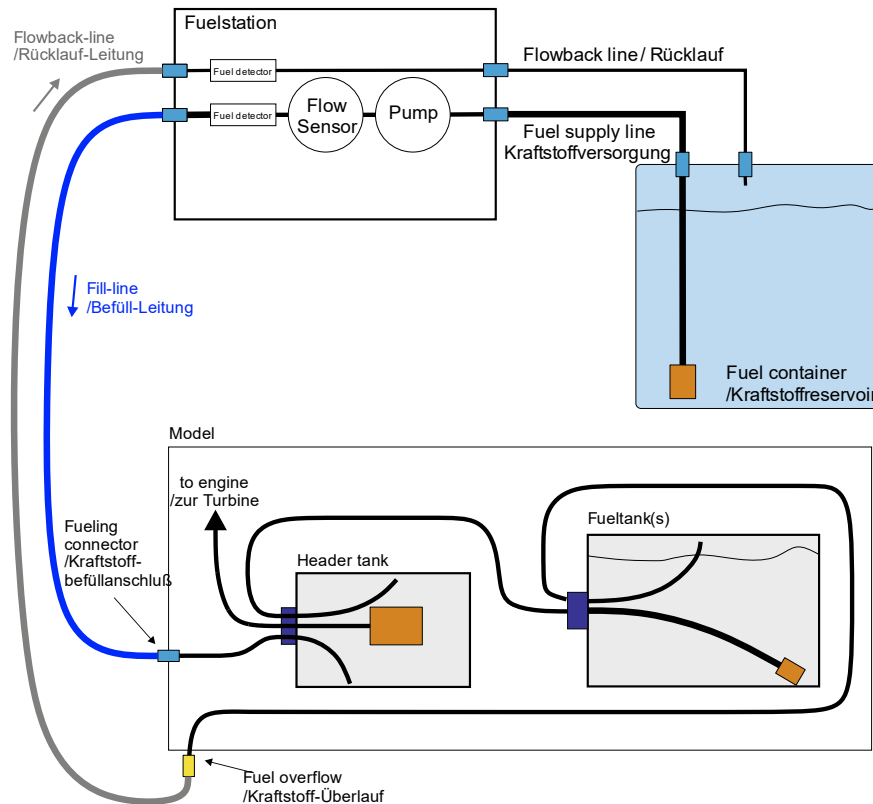

This is the ideal variant for normal or even complex tank systems, consisting of one or more "normal" fuel tanks connected in series (not for bag tanks!).

"Tank full" detection occurs with fuel flowback on the overflow pipe:

The tank overflow line, which is normally led out of the bottom of the model, must be connected to the flowback line of the fuel station!

Once all the fuel tanks have been filled, fuel flows back to the fuel station via the flowback line at the end of refueling. Typically, first, a mixture of fuel and air bubbles will flow back/escape from the tank overflow (→ Tanks are almost, but not quite full).

At that moment, the system is already reducing pump performance to counteract the excessive pressure rise in the model fuel system.

When the tanks are finally full, bubble-free fuel will eventually flow back to the fuel station. This circumstance is recognized by the system and evaluated as a "tank full" signal.

Now, the fuel pump is automatically reversed, and fuel is reverse pumped from the model tank until "air" is detected again on the flowback line instead of "fuel".

This causes overpressure possibly built-up during the refueling in the model tanks to be reduced. This pressure reduction is terminated precisely when no more fuel leaks out via the flowback line and instead air is sucked back from the fuel container into the flowback line. The refueling process is basically complete. In addition, an optional programmable volume (→ Drawback Volume parameter p.27) can be reverse pumped to possibly further drain the return hose or additionally decompress the system.

A1) Connection diagram for refueling a "normal" tank system without EZ-Fueler filling valve

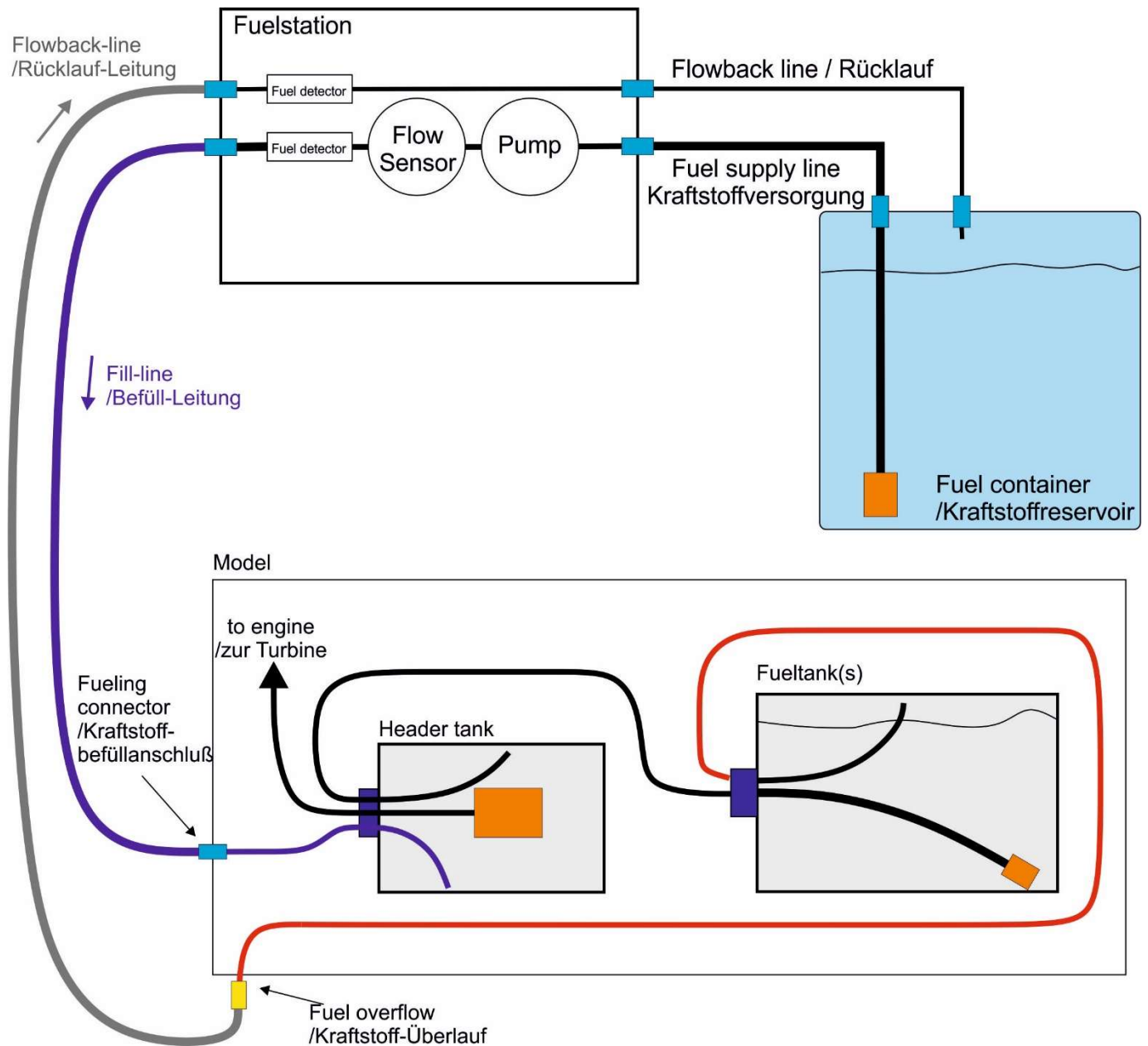

This results in the following filling cycle:

Fuel is first filled into the hopper tank from the blue filling hose.

If this is full, the fuel flows into the subsequent tanks until they are also full.

At this moment, the fuel then flows into the fuel overflow (or the tank vent hose). The fuel flows back into the filling station and from there into the fuel container via the flowback line, which is additionally connected to the model fuel overflow → a closed circuit.

The fuel flowing back via the overflow line is recognized by the detector in the fuel station and used to terminate the refueling process as soon as "bubble-free" fuel is detected in the flowback line.

A2) Connection diagram for refueling a "normal" tank system with the EZ-Fueler filling valve

Refueling position:

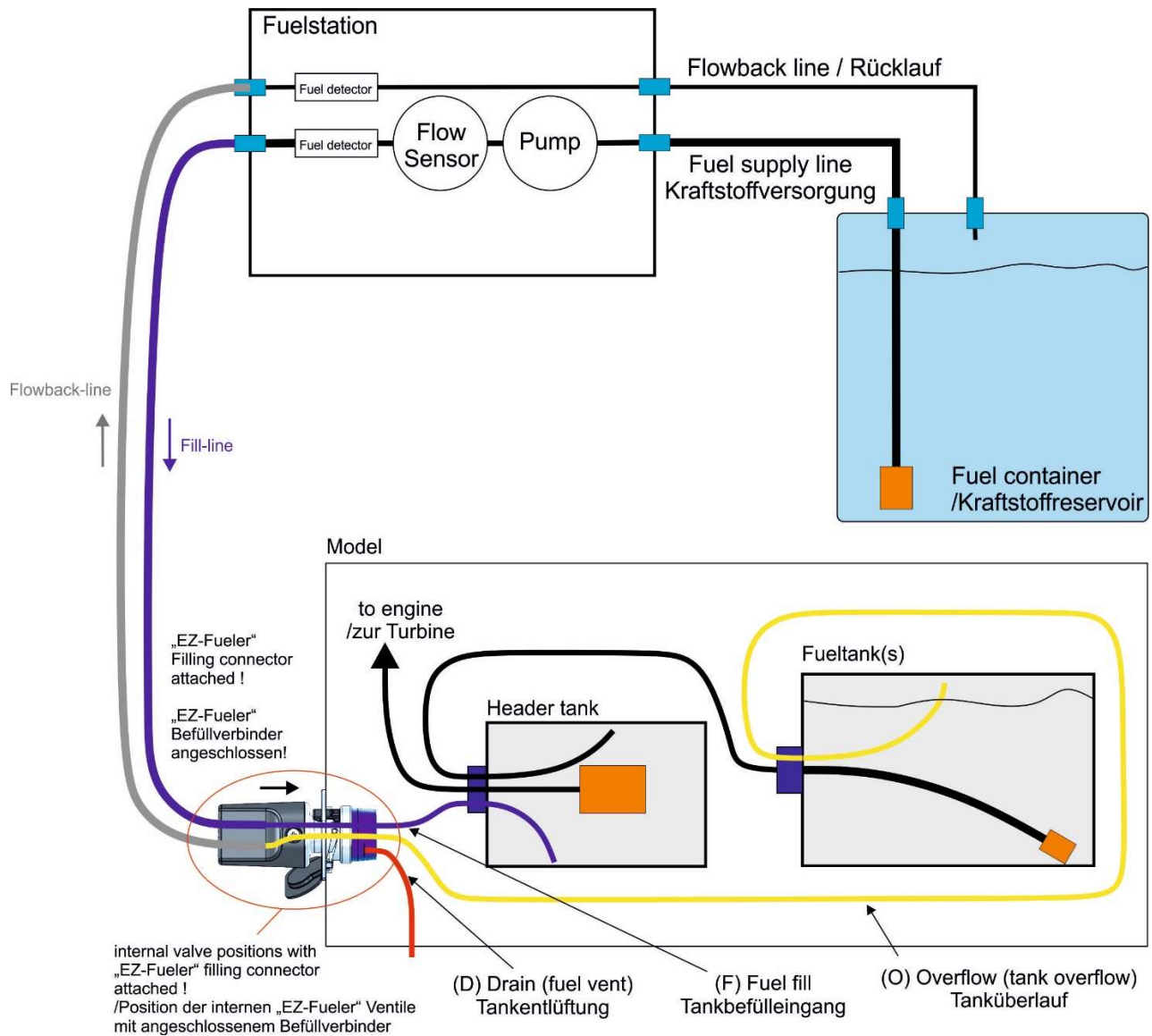

The figure above shows the valve position and the resulting connections when the "EZ-Fueler" filling connector is inserted (=filling position).

- ➔ The filling line of the fuel station is connected to the tank filling line.
- ➔ The tank overflow is connected to the return hose to the fuel station.

Flight position:

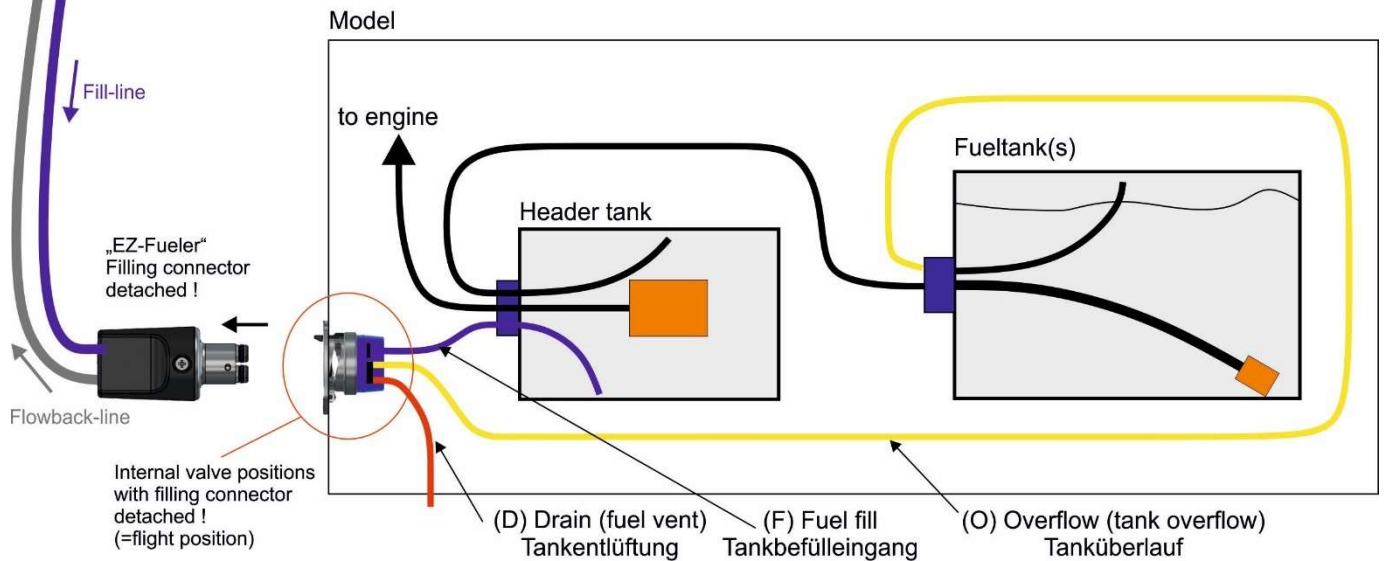
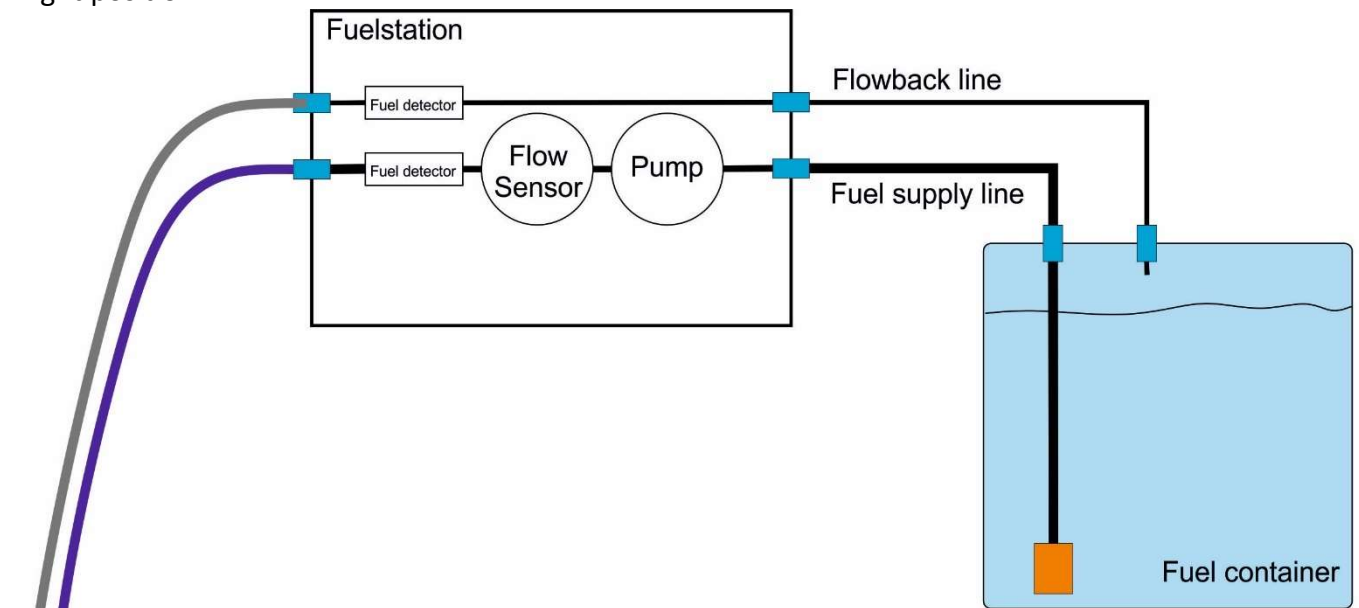

The figure above shows the valve position and the resulting connections with a disconnected "EZ-Fueler" filling connector (=flight position).

- ➔ Refueling connection actively closed
- ➔ Tank overflow connected to model overflow

EZ-Fueler features, summary

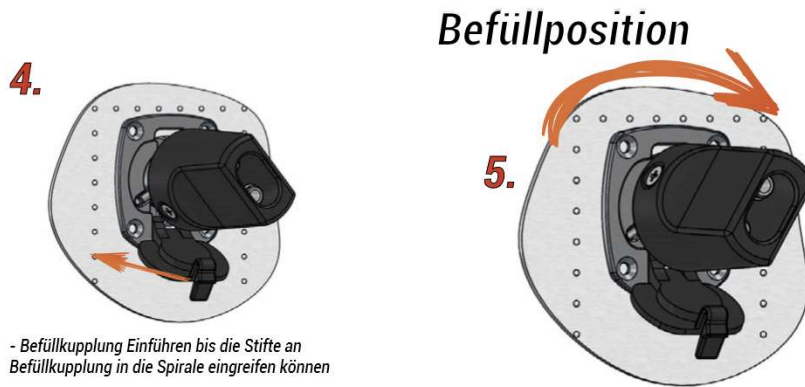
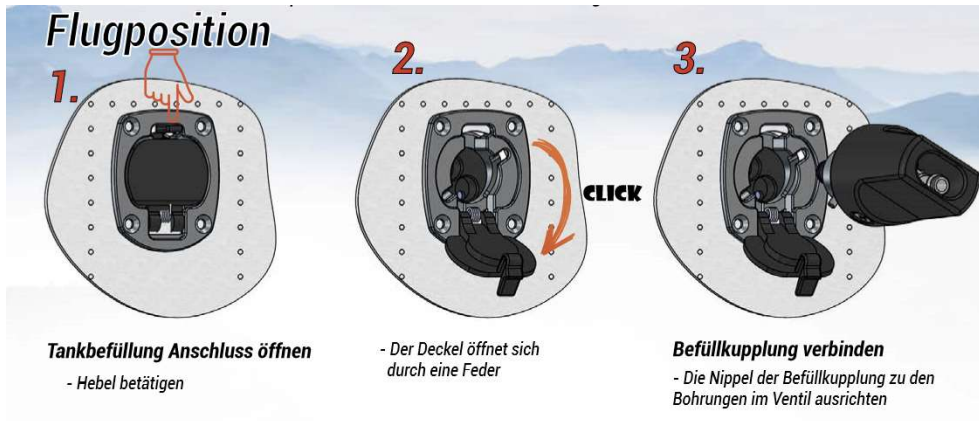

from fuel station/pump

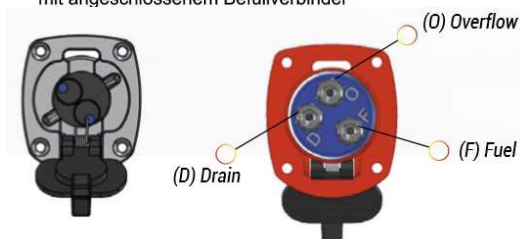
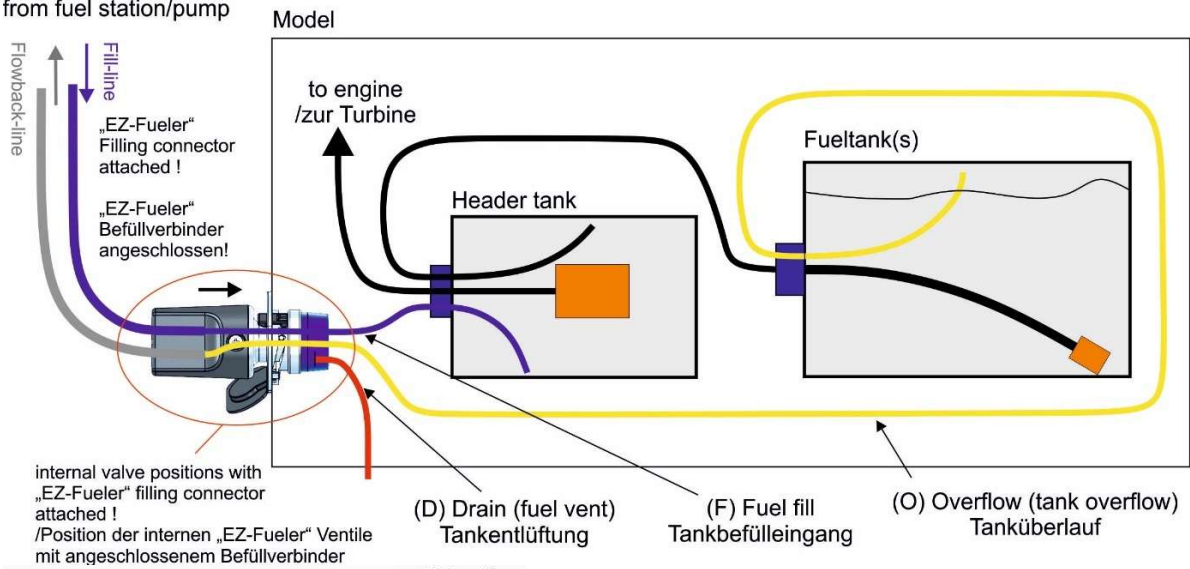

B) Connection diagram, refueling with only one filling line (without flowback line)

B1) Connection diagram for single bag tanks

This variant is used for bag tanks. As soon as the tank is full, the pressure in the tank will rise and fuel flow will drop slightly.

This circumstance is recognized by the system and evaluated as a "tank full" signal.



In this configuration, the flowback line is not used/analyzed!

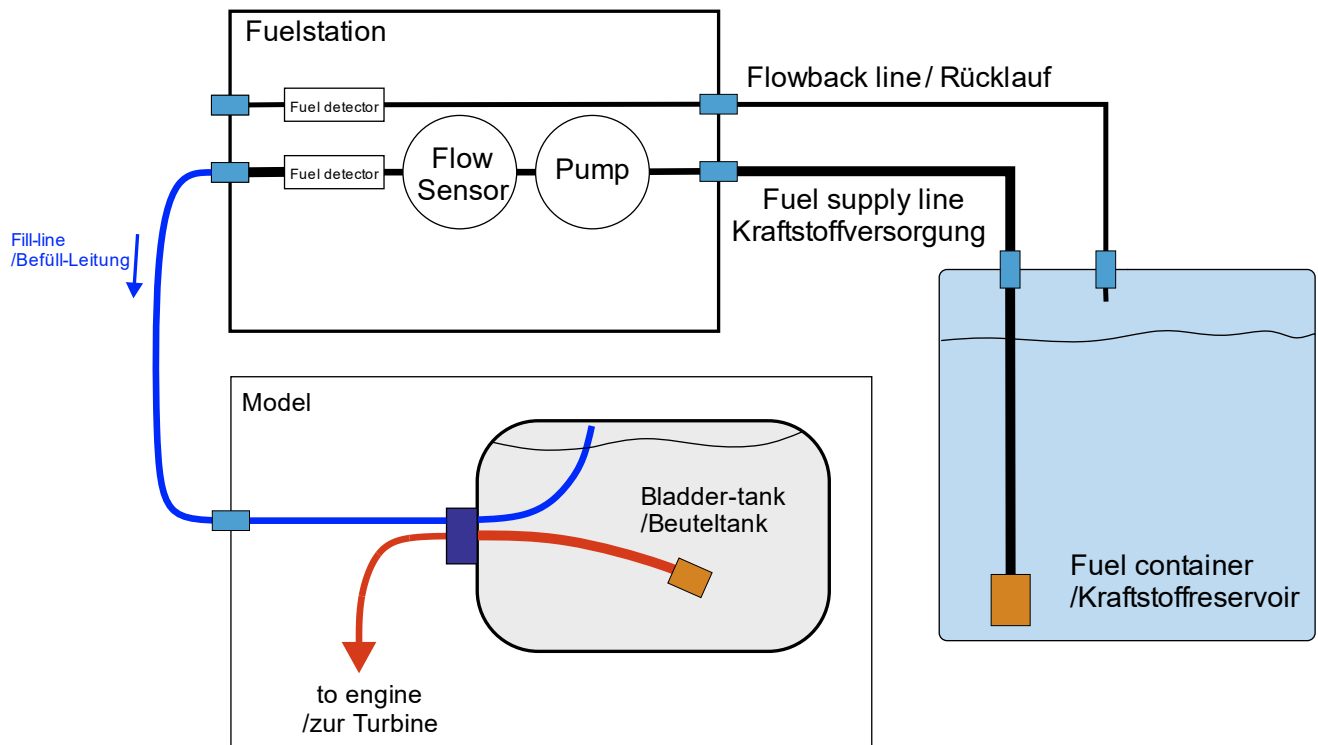

This results in the following filling cycle:

Fuel is first filled into the bag tank from the blue filling hose. If the bag is full, the pressure in the bag will increase and at the same time the fuel flow will drop slightly. This circumstance is recognized by the control of the fuel station and evaluated as a "tank full" signal. There is now an automatic drawback of fuel and/or air bubbles into the fuel station/fuel container. Should the situation arise, aspirated air bubbles are detected by the detector in the fuel station. Only when "bubble-free" fuel is sucked in (and detected), is it ensured that all air has been removed from the bag tank. If necessary, the system performs a second fill/drawback cycle to remove all air bubbles from the bag tank.

Once the air bubbles have been removed, the tank is completely refilled and then emptied by a defined volume (decompression).

You then have a full bag tank without overpressure.

B2) Connection diagram for multiple bag tanks

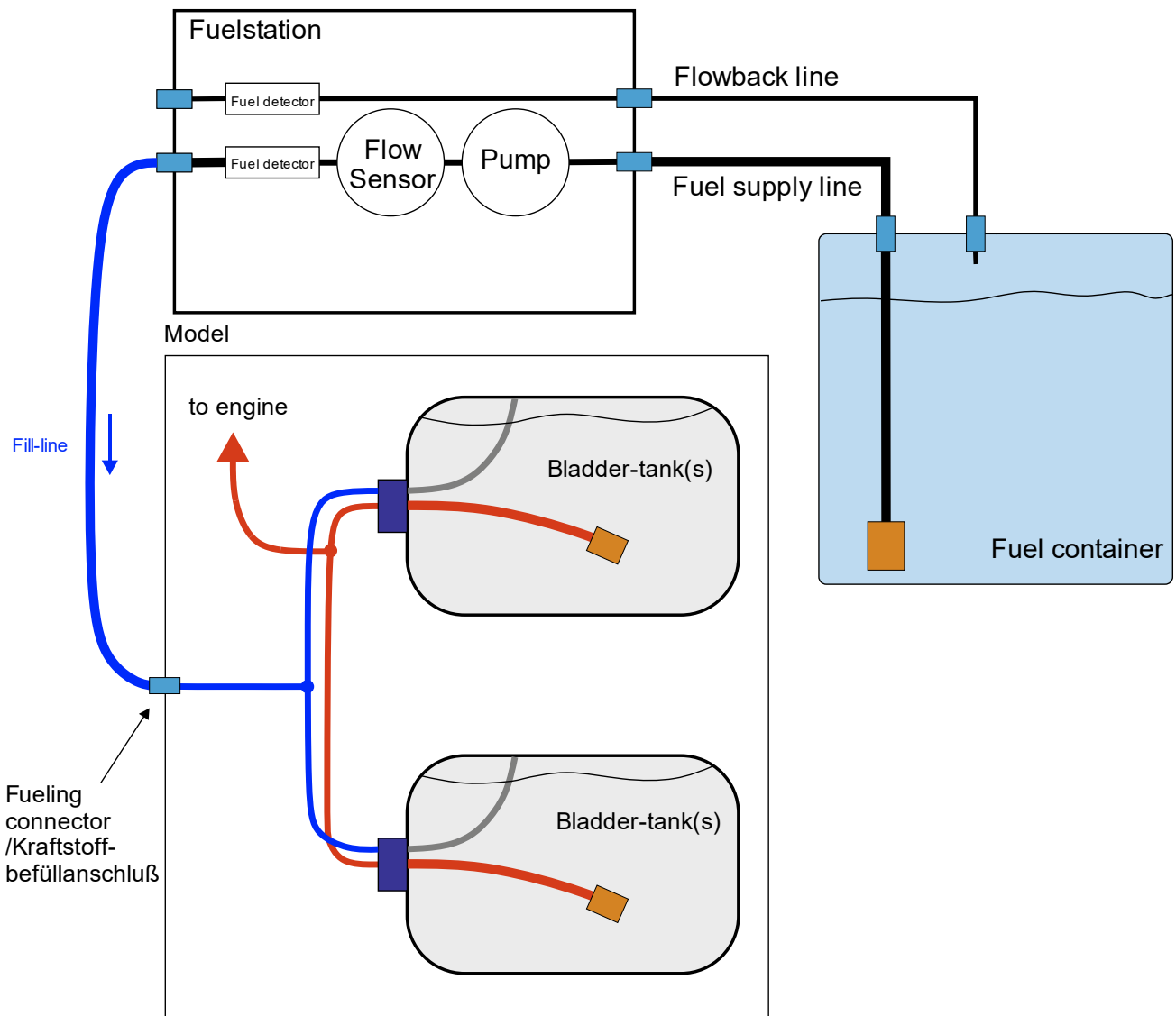

This results in the following filling cycle:

Fuel is first filled into the bag tank from the blue filling hose. If both bags are full, the pressure in the bags will increase and at the same time the fuel flow will drop slightly. This circumstance is recognized by the control of the fuel station and evaluated as a "tank full" signal. There is now an automatic drawback of fuel and/or air bubbles into the fuel station. Should the situation arise, aspirated air bubbles are detected by the detector in the fuel station. Only when "bubble-free" fuel is sucked in (and detected), is it ensured that all air has been removed from the bag tank. If necessary, the system performs a second fill/drawback cycle to remove all air bubbles from the bag tanks.

Once the air bubbles have been removed, the tanks are completely refilled and then emptied by a defined volume (decompression).

You then have a full bag tanks without overpressure.

B3) Refueling of single normal tanks without flowback line

This option is suitable for filling single "normal" tanks.

Tanks of the same size connected in parallel can also be conditionally filled (if they fill up quickly).

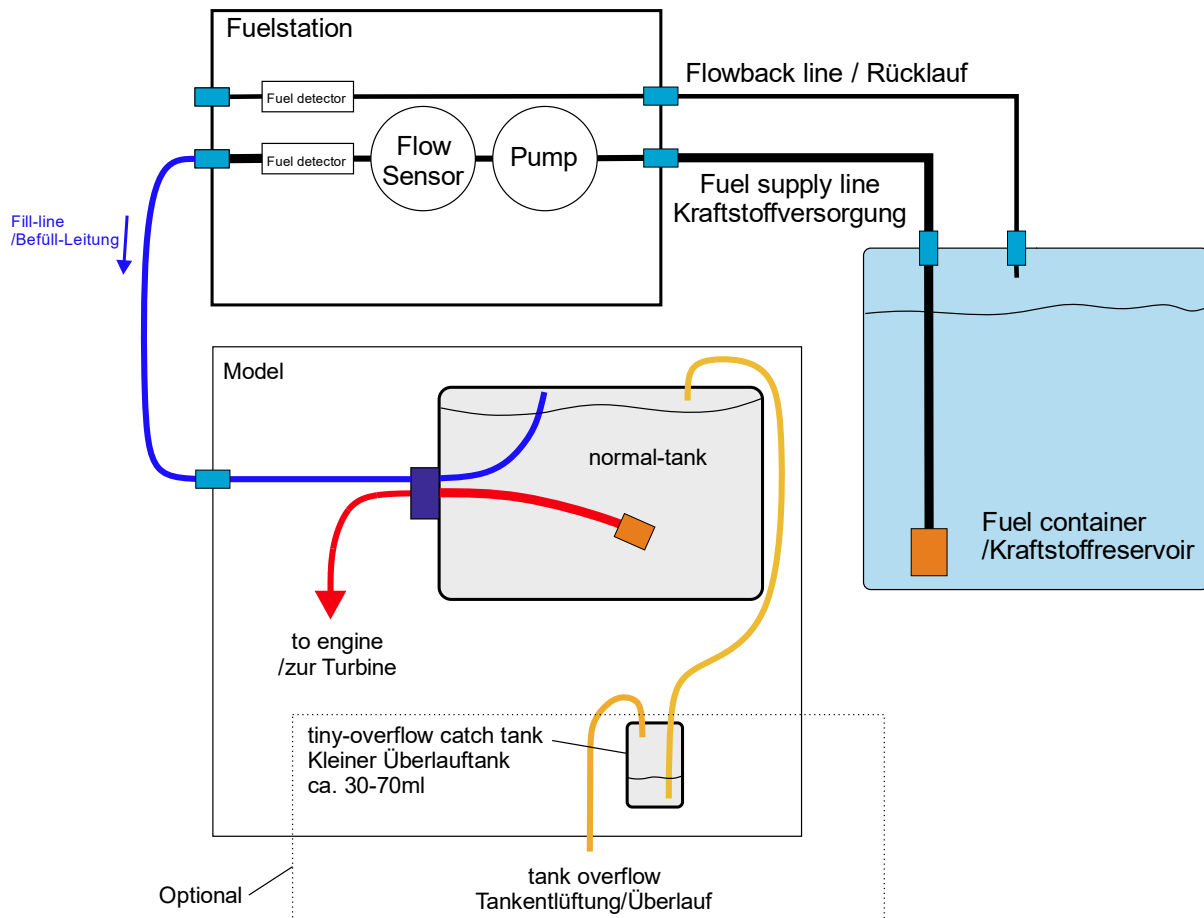

In normal tanks (not bag tanks) the fuel flow will also drop slightly as fuel flows into the tank overflow. However, if several such tanks are connected in series, this circumstance may occur several times until all individual tanks are full. Certain "tank full" detection is not guaranteed in these cases on the flow signal alone and the flowback line should be used! See option A).

However, the flow rate decrease can be used as a "tank full" signal for a tank system consisting of only a single "normal" tank. In this case, you can dispense with the connection of the flowback line. At the end of refueling, a small volume of fuel will escape from the overflow of the main tank (about 30ml). This overflow of fuel into the environment can be prevented by optionally interposing a small overflow tank before the actual overflow. This "mini-tank" then collects small amounts of fuel that could otherwise flow into the environment until the over-pressure trip triggers.

Advantage: A single refueling line is enough, and no fuel gets into the environment.

Disadvantage: Not suitable for series connection of several tanks.

Control panel

Overview of the control keys

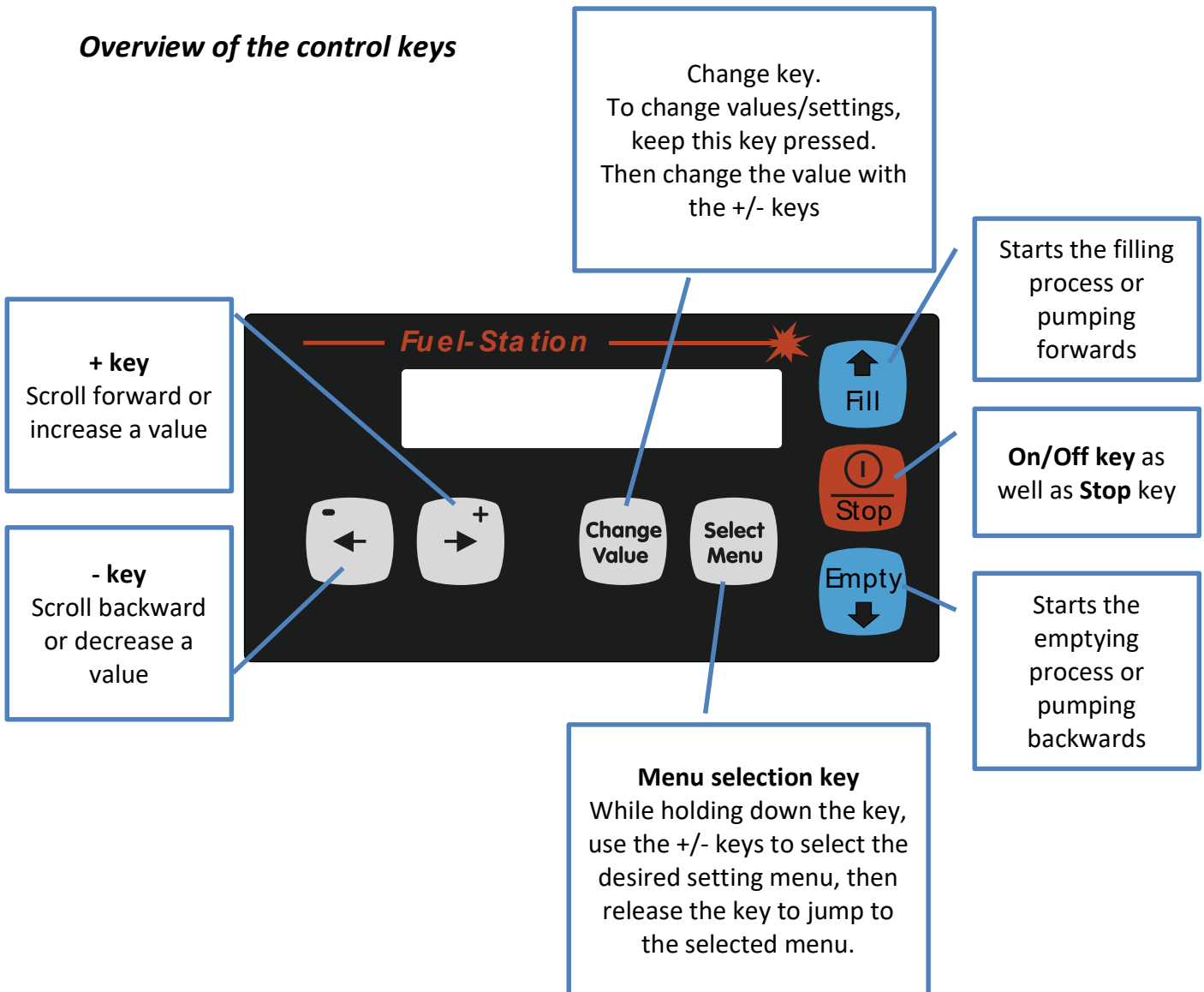

Commissioning/switching on

Power supply

For power supply, a corresponding battery must be connected to the MPX socket (bottom right).

Recommended batteries:

- 3s/LiPo 2500-5500mAh
- 4s/LiFePo4 2500-5000mAh

The battery type is defined in the System-Settings (also see page: 30) and may need to be adjusted. By default, the system is preset to a 3s LiPo battery.

The battery is preferably attached to the bottom of the fuel station with Velcro® straps. The effective battery type can be set in System-Settings (p. 30)



To charge the battery, be sure to remove it from the fuel station!

When storing the fuel tank with the fuel station attached, remove the battery for safety reasons! The system has no polarity reversal protection, reversing the polarity of the supply battery will destroy the electronics!

Switching on/off

Switch on by briefly pressing the  key.

Switch off by pressing and holding the  key for at least 1.5 seconds.

During this time, a "countdown" will appear in the display, if the key is released before the countdown, the system remains switched on!

Immediately after switching on, the display shows the following information for 2 seconds:

```
EZ-Fuel V12.01E ← Here the version number is displayed
Jet-A1, 5% Oil ← Here the container name is displayed (p.40)
```

Operating concept

The system can manage 20 different "models" with associated setting parameters.



For each model, the displayed name can be freely defined by the user.

On delivery, model numbers 1-3 are already set with predefined settings. It is possible to adjust these preferences at any time according to your own wishes.

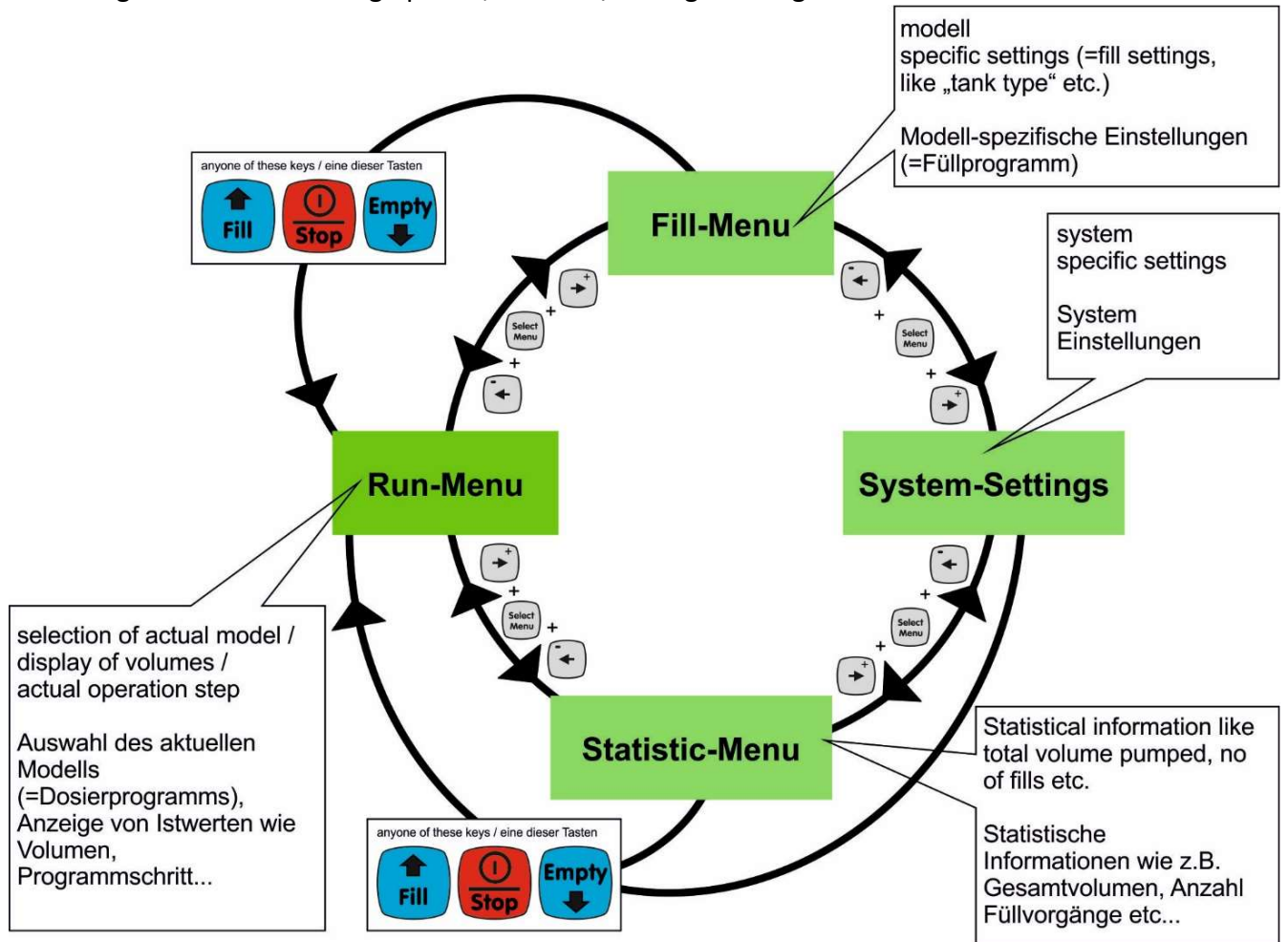
To manage the various setting options, the data/settings are organized in so-called menus:



Immediately after switching on, the Run menu is displayed. Here, the currently selected model (=dosing program) is always displayed in the upper line. The lower line displays additional information such as volumes/flow rate or the battery status.

You can switch between or select different menus by pressing and holding the  key and selecting the desired menu via the   keys. Pressing one of the "Fill", "Stop" or "Empty" keys will always cause you to jump directly back to the "Run menu" no matter which menu you are in. The top line always shows the name of the currently selected model (=fill program).

A refueling process can be initiated using the keys explained on page 35.

At the end of the refueling process, the display will show e.g.:



```
TankFull C=19.21
2101ml 3m26s
```

This display remains until either any key is pressed, or the fuel station shuts itself off after the inactivity time has elapsed.

If the fuel station has switched itself off in the meantime, the above-mentioned information will be displayed at the next switch on until a key is pressed.

It can thereby be established at the next switch on, what happened last or was executed.

If there are error messages, the same happens.

Menu structure

The following menus are available:



Menu Name	Purpose
Run menu From page: 24	Selection of the current model/filling program (#1-20) Display of the current operating status and program step Display of the volume delivered (liters) and the flow rate (liters/min) Display of the state of charge of the battery Display of the residual volume in the fuel container
Fill-Settings From page: 27	Setting/specification of the program parameters associated with the selected model, such as refueling speed, tank type, switch off criteria, volume etc.
System-Settings From page: 29	Definition of globally valid settings such as type of connected battery etc.
Statistics menu From page: 34	Statistical information, such as running times/total dosage volume etc.

Run menu

The so-called Run menu is used to select the current model/filling program (1-20) and to display the current operating status/program step, etc.

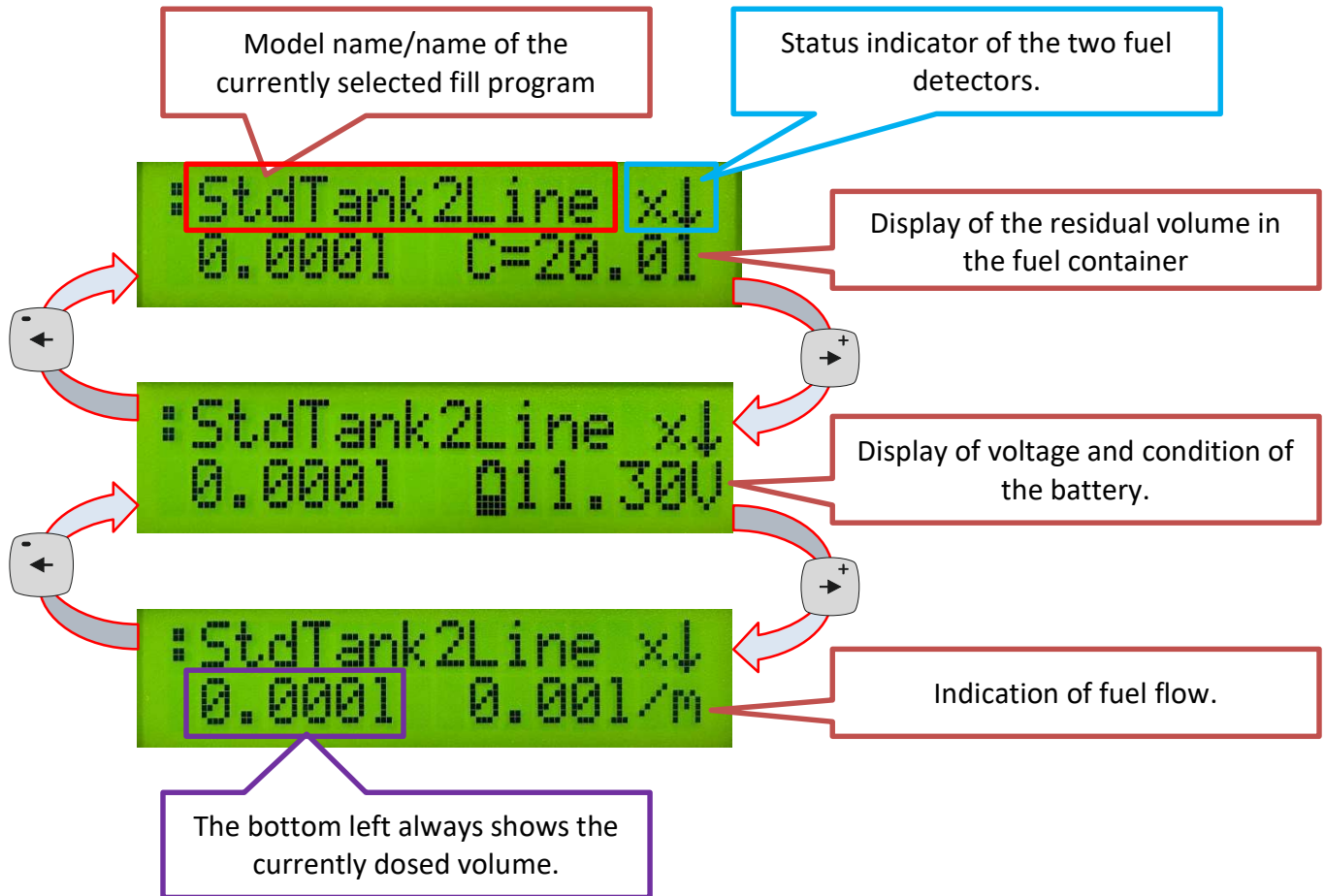



If the pump is not running, only the following 3 display options are available:



Switch between these 3 display options with the   keys.

Select model/filling program

In the upper line of the Run menu, the currently active model (=filling program) is always displayed.

To select a model other than the displayed model/fill program, the press and hold the  key and then select a different model with the   key. Then release the  key again.

A program is started via the key or key combinations explained from page 34.

When the pump is running, a fourth indication (program step display) is also possible:





The current program step and a progress bar for this program step are displayed here.

As soon as the pump is running, a symbol appears in the upper left corner which indicates the selected filling mode:





Explanation of symbols:

Symbol	Meaning
	"Tank filling" mode active
	"Tank emptying" mode active
	"Fill tank, then remove volume" mode active. (fill then remove)

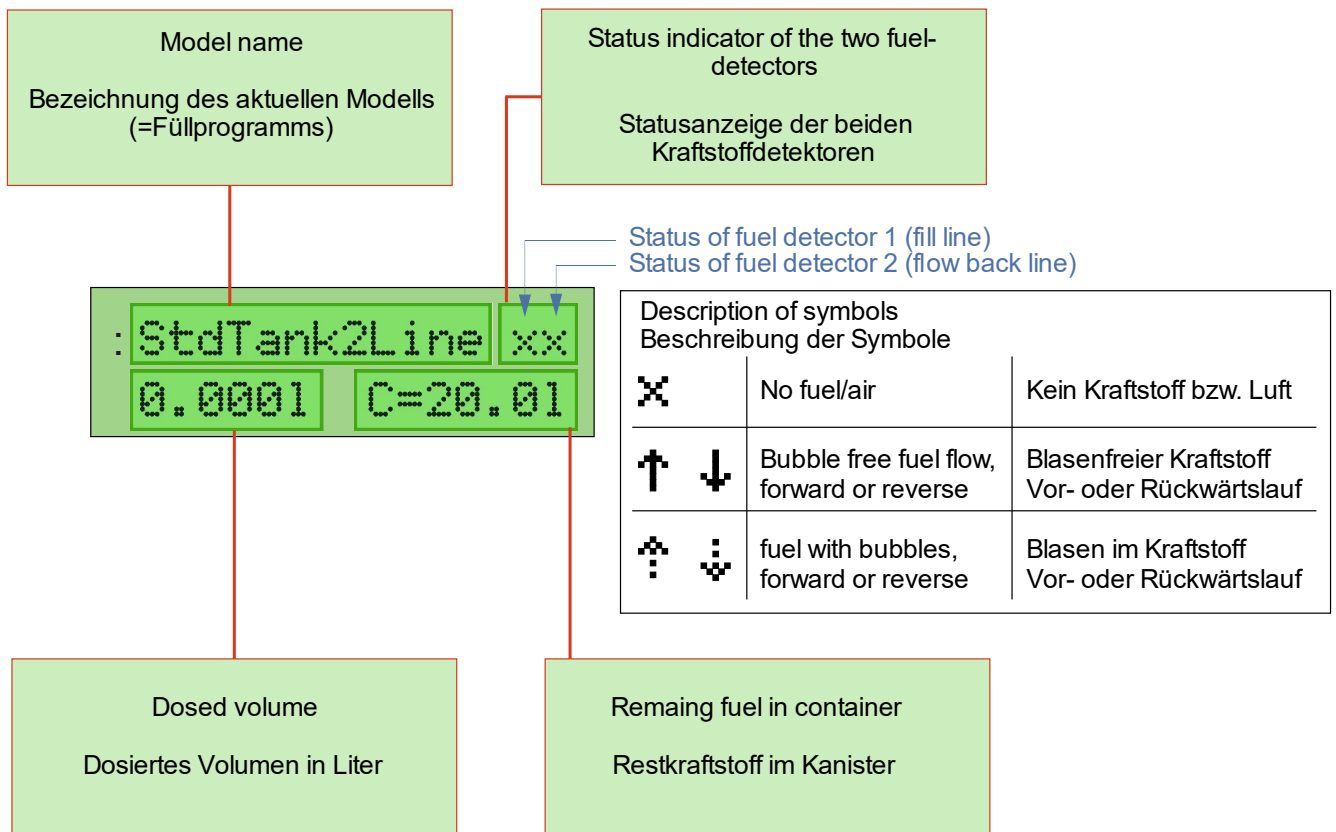
Explanation of the Run menu display



As soon as the pump is started or stopped, the system jumps to the overview display of the Run menu (also see page 24)!

While the pump is running, it is also possible to scroll through the display options with the   key.

While the pump is running, it is not possible to change the model/filling program. If this is still attempted, the display will show:

Value cannot
be changed!

Fill-Settings menu



The "Fill-Settings" menu is used to set/specify the program parameters associated with the selected model/filling program.



The settings made in this menu are all assigned to the selected (in the RUN menu) model (=filling program)!

Parameter Name	Options/ Value Range	Description
Fuel tank type	"Standard tank" "Bladder tank"	Defines the type of tank system to be filled. " Standard tank " =normal tank system of one or more "hard" tanks. The tanks can be connected in series or in parallel. " Bladder tank " =Bag tank of one or more bag tanks connected in parallel.
Stop-Signal	"Flow/Pressure " "2-line flowback"	Defines the shutdown signal to be used for "tank full" detection. Only available if "fuel tank type" is not set to "bladder tank". See also pages: 10-19 ! "Flow/Pressure" =switching off via pressure increase "2-line flowback" =shutdown via fuel return flow in the flowback line
Fill-PumpPower %	25-100% [80%]	Pump capacity during filling in % Reasonable values are between 40 and 95%. For bag tanks 80% is ideal.
Flow-Drop %	0.5-10%, [1.5%]	Definition of flow drop in % for "tank full" detection. Reasonable values are between 1.5 and 4%. A set value of e.g. 1.5% means that for full tank detection the flow rate must decrease by 1.5% Values that are too high (e.g. 10%) can lead to high pressure in the tank, values that are too low (e.g. 0.5%), to a possibly too early/premature shutdown.
AutoDecompress	0.0-2.0 ; [1.0]	Defines the scaling factor of the automatically calculated drawback volume when filling bag tanks (not available for other tank types).

Parameter Name	Options/ Value Range	Description
		<p>The larger this value is set, the more fuel is removed from the bag tank at the end of the filling process. This value influences, so to speak, how "plump" the bag tank should be.</p> <p>If automatic decompression is not desired, this value can be set to zero (0), the function is then deactivated.</p> <p>The drawback quantity/decompression quantity can then optionally be adjusted additionally with the parameter "Drawback vol[ml]".</p> <p>This parameter is only available/visible if the parameter "tank type" is set to "bladder tank".</p>
Drawback vol[ml]	0-5000ml	<p>The drawback volume at the end of the filling process after the "tank full" signal has been detected. If a value other than zero is set here, this amount is drawn back from the tank.</p> <p>This setting is used for the defined decompression/drawback of fuel from the tank so that no more fuel drips.</p>
Fill Limit [ml]	0-65000ml	<p>If the quantity set here is exceeded when filling the tank, the refueling process is aborted!</p> <p>This value serves as a limit value in order to pump fuel when there is no leakage. Typically, one sets here the maximum tank capacity plus e.g. 10%.</p>
FillVolume[ml]	0-65000ml	<p>This value defines the dosing volume in dosing mode which is dispensed per step.</p>
RemoveVolume [ml]	0-65000ml	<p>This value defines the volume to be removed in the operating mode "Fill and then remove defined volume" operating mode as well as the drawback amount which is extracted per step in the reverse dosing operation.</p>
Pullback first		<p>This setting defines whether refueling should always draw in fuel from the model tank first.</p> <p>The reverse aspiration of fuel before the actual filling process has the advantage that air possibly located in the filling hose is not pumped directly into the model tank (e.g. hopper tank). By reverse aspiration, the filling hose is first flooded with (residual) fuel from the model tank, or the air is pumped back into the fuel container until "bubble-free" fuel is detected by</p>

Parameter Name	Options/ Value Range	Description
	"DISABLED" ["ENABLED"]	<p>the sensors. Only then does the actual refueling process begin.</p> <p>If this parameter is set to "DISABLED", the initial aspiration is disabled.</p> <p>If the parameter "tank type" is set to "bladder tank", this parameter is not visible and is always activated internally, since with these tanks the pumping of air into the tank unnecessarily is to be avoided!</p>
Min Reverse Time	2-20 sec	<p>Minimum time to pull back fuel.</p> <p>Bubble-free fuel is withdrawn from the tank during this time. With small tanks it may make sense to set the time to smaller values.</p> <p>When refueling with a single fill line (e.g. bladder tank), the value ranges from 6-20s.</p> <p>When refueling with a return line, the value ranges from 2-20s and is only effective if the "Pullback first" parameter is set to enabled.</p>

Switch between the different parameters with the   key

To change a value press and hold the  key and change the value with the   key.

Values in brackets [] indicate the standard values.

System-Settings menu

Parameter Name	Options/ Value Range	Description
Battery Type	"LiPo 2Cell/7.4V", ["LiPo3Cell/11.1V"] "LiFe 3Cell 9.9V", "LeadBatt 12V " "LiFe4Cell 13.2V"	Type and cell number of the supply battery 2-cell LiPo (not recommended!) 3-cell LiPo (standard value) 3-cell LiFe 12V lead acid battery 4-cell LiFe
Empty-PumpPow %	20-100 [70]	Pump capacity in % during defueling/reverse pumping. Important: Do not set the pump capacity too high for the reverse operation, otherwise cavitation bubbles may develop on the suction side, making the measurement of the pumped volume inaccurate. Furthermore, too high a pumping capacity during defueling can also lead to contraction of tanks connected in series. Reasonable values: 35-80%;
AutoOff Time	30-1000 [4min]	Time until automatic shutdown if the system is not in use (inactivity time)
MaxRunTime Pump	30-1000 [18min]	Maximum allowed continuous running time of the pump. If this time is exceeded, the system switches off.
MinReversTime [s]	4.0-20.0 [10.0s]	(When defueling) Initial minimum aspiration time. During this time, the refueling line is not checked for air bubbles (the emptying process is terminated by the detection of air in the refueling line). If this time is set too short, defueling may be ended too soon, as fuel could not be aspirated by the pump if necessary.
TankEmptyTime [s]	0.1-20 [3.0s]	(When defueling) How long continuous air on the refueling line has to be detected to complete the defueling process.
Ovfl BlankTim[s]	0.1-60 [10.0s]	(When refueling with flowback line) Minimum time before the flowback line is checked for the first time for liquid in the fuel return (makes the system insensitive to possible initial residual fuel which may still be in the flowback line at the start of the tank, e.g. from the previous refueling process).
FuelDetectTim[s]	0.1-20 [2.0s]	(When refueling with flowback line) Minimum time for bubble-free fuel in the flowback line for "tank full" detection.

Parameter Name	Options/ Value Range	Description
Max Air AspirTime	5-200 [40s]	(When refueling bag tanks) Maximum time in seconds to attempt to aspirate air bubbles from the bag tank. If bubble-free fuel returns from the tank within this time, the next step is triggered immediately.
Container Volume	0-100 liters	Defines the max. capacity of the fuel container in liters. If the fuel container is refilled/replaced by a full one, the container volume can be reset to the initial value which can be set here by pressing the "Fill" key when switching on (see also p.38). The container volume is for information only for the user to estimate if there is enough fuel left.

<p>PowerOff Action</p>	<p>["Empty Lines"] "DISABLED"</p> <p>"Flush Filter"</p>	<p>If there is fuel in the filling line, this can be automatically reverse pumped into the fuel container when the fuel station is switched off manually.</p> <p>If activated, the pump is still operated in reverse for a short time after switching off the fuel station (via the "Stop" key) in order to empty the hoses. Fuel contained in the hoses is pumped back into the fuel container.</p> <p>The display shows the following during this time:</p>  <p>During automatic shutdown of the fuel station (in case of inactivity) this function is suppressed, as it is not certain whether the refueling hoses are still connected to the model!</p> <p>ENABLED activates this function, DISABLED disables this function</p> <p>Automatic reverse pumping can be interrupted at any time by pressing the Stop key again, the system then switches off immediately.</p> <p>This option allows the situational "flushing" of the filter / suction pendulum in the fuel container. Background: If the last action (prior to manual shutdown of the fuel station) was a "defueling" operation, it is possible that dirt particles from the model side tank were pumped / deposited into the filter of the fuel station. In a subsequent refueling process, these dirt particles would then possibly be transferred from there into the model tank. To prevent this, the pump can be automatically forward-activated before the fuel station is completely switched off (the fueling line must be connected to the return line, of course!). In this pumping process "in a loop mode", dirt particles from the interior of the suction filter are then flushed back into the fuel container via the return hose. The "Flush Filter" option always automatically includes the "Empty Lines" function, so at the end of this process, the pump will run backwards for a short time to empty the fuel lines.</p> <p>The flushing process must be confirmed by the operator by pressing the "+" button within 5 seconds, otherwise the</p>
------------------------	---	--

Parameter Name	Options/ Value Range	Description
		fuel station switches off normally without flushing. The "Flush Filter" process is only suggested by the system if previously a defueling process happened, and effectively a minimum amount of fuel has been aspirated!
Burst Protection	"DISABLED", "Low sensitivity" "Medium sensitivity" ["High sensitivity"] "Ultra-sensitive"	Protection system to avoid the bursting of fuel tanks if the tank overflow has not been opened, or even if, for example, a bag tank is falsely refueled with a program that only analyses the flowback line. In both cases, an impermissible high pressure will be created in the tank system, which may lead to a tank bursting. If this function is active (i.e. not "DISABLED"), the current fuel flow is compared with an automatically determined mean value. If the current flow rate drops too much, refueling is aborted with the error message "Overpressure → STOPPED!".
Fill-line break	"Checking OFF" ["Checking ON"]	Automatic shut-off when refueling hose unintentionally "falls off"/disconnects during filling. In this case, the flow will rise abruptly, this circumstance is evaluated as a shutdown criterion. If this function is activated, the refueling process is interrupted with the error message: "Fill-line disconnected!".
FillLine Sensit	1.0..2.0	Sensitivity of the "Fill-line break" function. Default: 1.1 ; higher values make system less sensitive! Lower values make the system more sensible.

Values in brackets [] indicate the standard values.

Statistics menu

Parameter Name	Description
Total Run-Time	Total running time of the pump
TotalFuel pumped	Total conveyed amount
No of fills	Number of fills
No of drains	Number of emptying operations
LoBatt counts	Number of undervoltage trips

Scroll between the different parameters with the   key.

The values are only for display/information and cannot be changed.

Tables with key commands



Before starting a filling or emptying process, the hose connections must be made properly!



Also, make sure that the correct model with the appropriate fill mode has been selected!



















For example, if a bag tank is in the model to be refueled and is falsely refueled with a program for normal tanks using the flowback line, this may cause the bag tank to rupture because in this mode of operation, no analysis of the flow to terminate refueling occurs! See also the Burst Protection parameter in the System-Settings.

In order to give the user an acoustic feedback, which tank type is selected, an acoustic signal is always given when starting the refueling process, which characterizes the shut-off signal used for "tank full" detection:

One beep: shutdown via flow detection active, i.e. flowback line does not have to be connected.

Three beeps: Shutdown via flowback line active, i.e. flowback line must be connected!







Key commands, filling functions

Action	Key(s)
 <p>Start automatic filling process, fill tank completely according to the program.</p>	 1x
 <p>Start automatic emptying process, empty tank completely.</p>	 1x
<p>Deliver a defined volume. The volume defined under "Fill volume" is delivered.</p>	 Press twice in succession (about 1s in between)
<p>Aspirate the defined volume. The volume defined under "Remove-volume" is removed.</p>	 Press twice in succession (about 1s in between)
 <p>Start automatic filling process followed by a defined removal of a programmable volume. The volume defined under "Remove volume" is removed from the tank after it has been filled.</p>	 +  (Press and hold "Fill", then press "Empty")
<p>Completely empty the tank and then fill the volume defined under "Fill Volume".</p>	 +  (Press and hold "Empty", then press "Fill")
<p>Start direct manual filling with automatic shutdown. Pump runs forwards until a shutdown condition occurs</p>	 +  (Press the "Change value" key first!)
<p>Start manual filling. Pump runs continuously forward until the Stop key is pressed! All automatic shutdown conditions are disabled</p>	 +  (Press the "Select Menu" key first!)
<p>Start manual emptying Pump runs continuously in reverse until the Stop key is pressed! All automatic shutdown conditions are disabled</p>	 +  (Press the "Select Menu" key first!)
<p>Stop filling/emptying or stop the pump immediately.</p>	 Press once briefly

Key commands, special functions







The fuel station must be switched off!

When switching on the fuel station (using the  key) additionally press and hold the keys listed in the table.











Action	Key(s) to additionally press and hold when switching on
Changing the model name (fill program name)	
Resetting the container volume	
Changing the container name	
Resetting the values of the Statistics menu	
Resetting the system to factory settings	 and 
Calibrating the flow meter	

Quick Start Guide







1) Selecting a new model and naming it

- 1) With the fuel station switched on, press the  key once briefly to access the Run menu.
- 2) Press and hold the  key and choose a free model location  .
- 3) Turn off the fuel station (press and hold  key for at least 1.5 seconds)
- 4) Enter/define the model name by following the instructions on page 39.
(→ Press and hold the  key when switching on to access the model name setting function).

2) Defining refueling settings

- 1) With the fuel station switched on, press the  key once briefly to access the Run menu.
- 2) Check whether the desired model is displayed in the upper line.
If not, select the desired model while holding down the  key with the   keys!
- 3) Press and hold the  key and press  once to select the "Fill-Settings" menu.
- 4) Now make the settings for the model tank (see also page 27):
You can scroll through the menu with the   keys. To change a value, press and hold the  key and with the   keys set the value.

3) Selecting model and start fueling process

- 1) With the fuel station switched on, press the  key briefly once to access the Run menu, or press  repeatedly until the Run menu is displayed.
- 2) Check whether the desired model is displayed in the upper line.
If not, select the desired model while holding down the  key with the   keys!
- 3) Make hose connections to the model!
- 4) Press the  key to start the automatic refueling process.
- 5) If necessary, the fueling process can be terminated at any time by pressing .

Resetting the container volume

If the fuel container is full, it may be necessary to reset the volume meter of the container volume to "full".

To reset the counter for the "container volume" (=remaining fuel quantity in the fuel container), proceed as follows:

First switch off the fuel station!

Then:

Press and hold the  key and then switch on the fuel station by pressing

the  key again.

The display shows:

```
Reset Container
Press <+> if OK?
```

Now release all keys.

To confirm press the  key, all other entries cancel the function.

When the function has been confirmed, the display shows:

```
Container Vol
reset to full!
```

The container volume counter is thus again set to the maximum value (e.g. 20 liters).

The maximum value (=Max. capacity of the fuel container) can be set in the System-Settings menu (see p.27).

Changing the model name (fill program name)

To change/set the current model name, proceed as follows:

First switch off the fuel station!

Then:

Press and hold the  key and then switch on the fuel station by pressing

the  key again.

Now the setting function for changing the model name is selected, the display shows e.g.:



```
Edit ModelName:  
F16-3000ml
```

The modification/editing of the model name displayed in the bottom line must then be carried out as follows:

Use the   keys to move/position the cursor horizontally

To change the character at the cursor position **press and hold** the  key and now change/set the character with the   keys.

Tip:

To quickly jump to the letters "a"/"A" and digits "0" and the space "", you can repeatedly press the  key while holding down the  key! This can save some time for the otherwise necessary "scrolling through" of the characters.

In this way, the entire model name can be freely set/defined.

To save/terminate the function finally press the  key. This saves the setting. The system then goes into normal operation.

Changing the container name



Immediately after switching on, the so-called "Container Name" is displayed in the bottom line. This freely definable name should be used to identify the contents of the fuel container (e.g. Jet-A1, smoke oil, 4-stroke fuel etc.).

```
EZ-Fuel  U12.01E
Jet-A1 + 5%Oil
```

When delivered, the name of the container is "Jet-A1 + 5%Oil".

To change/set the container name, proceed as follows:

First switch off the fuel station!



Then: Press and hold the  key and then switch on the fuel station by additionally pressing the  key.

Now the setting function for changing the container name is selected, the display shows e.g.:



```
Edit Container:
Jet-A1 + 5%Oil
```

Changing/editing the container name displayed in the bottom line is then possible as follows:

Use the   keys to move/position the cursor horizontally

To change the character at the cursor position **press and hold** the  key and now change/set the character with the   keys.

Tip:

To quickly jump to the letters "a"/"A" and digits "0" and the space "", you can repeatedly press the  key while holding down the  key! This can save some time for the otherwise necessary "scrolling through" of the characters.

In this way, the entire container name can be freely set/defined.



To save/terminate the function finally press the  key. This saves the setting. The system then goes into normal operation.

Service functions

Resetting the values of the Statistics menu

To reset the statistics values, proceed as follows:

First switch off the fuel station!

Then: Press and hold the  key and then switch on the fuel station by additionally pressing the  key.

The display shows:

```
Reset STATISTICS?  
<- =NO , YES ->
```



Now release all keys.

To confirm press the  key, all other entries cancel the function.

Resetting the system to factory settings

To reset the fuel station to the delivery condition, proceed as follows:

First switch off the fuel station!

Then: press and hold the  and  keys at the same time then switch on fuel station with the  key.

The display shows:

```
Reset SYSTEM?  
<- =NO , YES ->
```

Now release all keys.

To confirm press the  key, all other entries cancel the function.

The system is reset to factory settings, all model memories/settings are deleted!

Calibrating the flow meter

To calibrate the flow meter, either a measuring cup (e.g. 2000-5000ml) with a precise volume scale or a balance (measuring range of at least 3000g) is required.

Test setup:

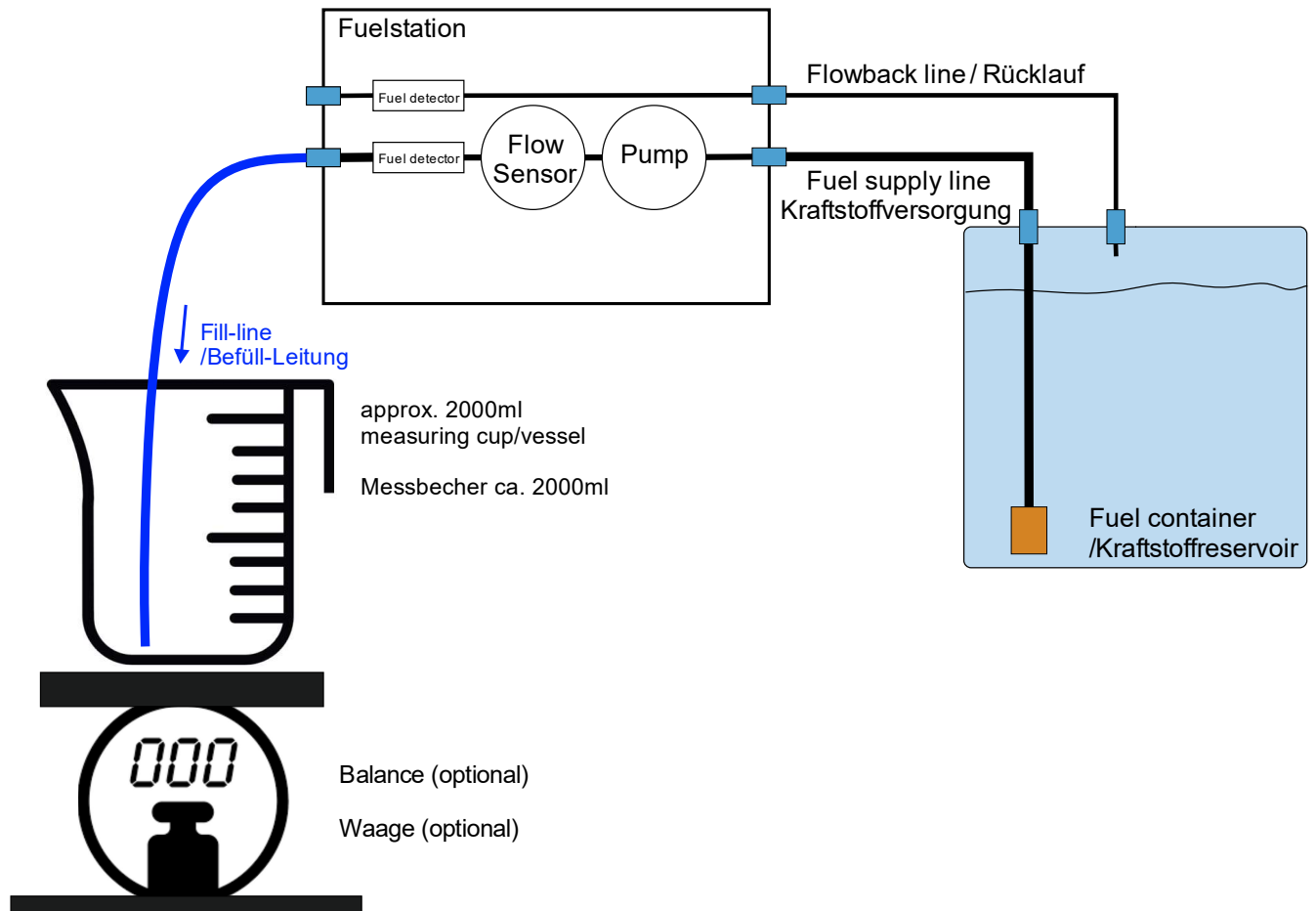

Procedure:

The calibration procedure is divided into three steps:

Step 1: The target vessel is first "interactively" filled with a certain starting amount.

This is to fill the hoses and to get a certain "liquid start level" in the measuring vessel (for the directly subsequent calibration for the reverse operation of the pump).

Typically, at least about 500ml should be filled to have a sufficiently large buffer. The exact amount does not matter!

Once the starting quantity has been poured in, the actual calibration process begins by reading this initial value and entering it in the system.

Step 2: Next, the pump is started in forward mode (at least 1 liter should be dosed to get sufficient measurement accuracy).

The exact amount does not matter!

This second measured value is again read and entered into the system.

Step 3: As a last step, the pump is operated in reverse. The user must finish the process in good time before the measuring vessel is empty or air is sucked in! Again, at least 1 liter should be pumped back. The exact amount does not matter!

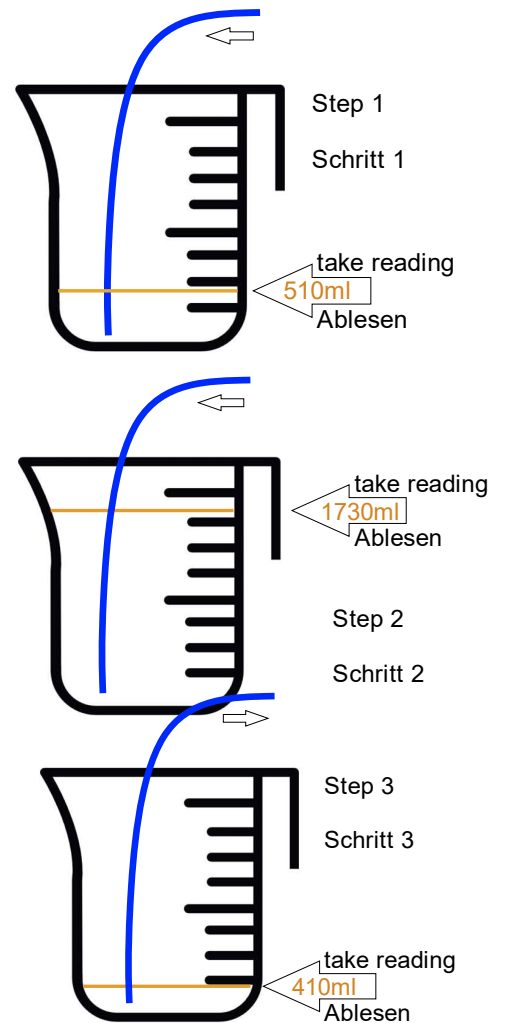

This third and last measured value is in turn entered into the system. From the three measured values, the fuel station calculates the difference quantities and then the calibration values for the forward and reverse operation of the pump.

The 3 readings are either the absolute read volume values on the measuring cup, or alternatively the read weight values of an underlying balance. If you want to work with weight values (scales), the system still allows you to enter the specific weight of the medium.



To select the calibration function of the flow meter, proceed as follows:

First switch off the fuel station!

Then: Press and hold the  key and then switch on the fuel station by additionally pressing the  key.

The display shows:

```
Cal. FlowMeter
<- =NO , YES ->
```

Now release the keys.

To confirm now press the  key, all other entries cancel the function.

The system now asks if calibration of the flow meter should be done by weight or volume measurement:

```
Cal. by weight?
<- =NO , YES ->
```

To calibrate using a weight measurement press the  key (scales necessary), all other keys select calibration via volume inputs.

If calibration by weight measurement has been selected then the specific weight of the fuel must be entered afterwards, otherwise the following query is skipped:

```
specific weight  
0.79 kg/liter
```



With the   keys, the value can be set, to confirm press the  key.



Table with specific weights of different fuels/media:

Specific weight (kg/liter)	Medium
0.80	Jet-A1
0.75	Petrol
0.79	Methanol fuel
0.855	Smoke oil/paraffin oil
0.84	Diesel
0.88	Biodiesel

Step 1:

The first step is the interactive filling of the lines:

```
flush lines via  
FILL/EMPTY keys
```



With the   keys, the pump is now interactively forward or reverse operated.



Fill the lines with this and add a certain initial amount e.g. approx. 500ml into the target vessel. At the end of the process, all lines must be free of air and about 500ml liquid in the target vessel.

When finished, press the  key. The system now asks for the first quantity or weight value:

```
Start value:  
530 (ml/gram)
```

Read off the measured value on the measuring cup or the balance and enter it as the start value.

With the   keys, the value can be set, to confirm/continue press the  key.

Tip: To quickly adjust the value in addition to the   keys press and hold the  key!

Step 2:

The system is now ready to start the pump in forward mode.

```
dispense via  
FILL key..
```

Important: Keep the filling line in the measuring cup!

As soon as you are ready, press the  key.

The system now doses forward as long as the  key is pressed.

```
dispense via  
FILL key.. 304
```

If a sufficiently large quantity (at least 500ml!) has been poured in, release the Fill key.



To continue press the  key.



If pressing the "Select menu" key has no effect, not enough liquid has been dispensed (the bottom left control counter must reach at least 300)!

Next, the system asks for the second quantity or weight value:

```
EndDose value:  
2150 (ml/gram)
```

Read off the measured value on the balance or measuring cup and enter it as the end value.

With the   keys, the value can be set, to confirm press the  key.

Tip: To quickly adjust the value in addition to the   keys press and hold the  key!

The acquisition of the measured values for the forward operation is thus finished and now the detection for the reverse operation of the pump takes place!

Step 3:

In the following, the pump is operated backwards, i.e. liquid is pumped out of the measuring cup. The user has to let the pump run by pressing a key until a sufficiently large amount has been pumped back (at least 500ml) and stop in time before the target vessel is empty!
Important: Keep the filling line close to the bottom of the measuring cup so that liquid can be pumped out; no air may be sucked in!

The system is now ready to start the pump in reverse mode. The display shows:

```
Remove fuel via  
EMPTY key..
```

Important: Keep the pipe in the measuring cup below the liquid level so that no air is sucked in!

As soon as you are ready press and hold the  key.

```
Remove fuel via  
EMPTY key.. 354
```



The system pumps backwards as long as the  key is pressed.



If a sufficiently large amount (at least 500ml!) has been pumped back, release the "Empty" key.

To continue press the  key. If pressing the "Select menu" key has no effect, not enough liquid has been dispensed (the bottom left control counter must reach at least 300)!

Next, the system asks for the third quantity or weight value:

```
EndAspir value:  
620 (ml/gram)
```

With the   keys, the value can be set, to confirm press the  key.

Tip: To quickly adjust the value in addition to the   keys press and hold the  key!

From the entries made, the system calculates the calibration factors for forward and reverse operation and displays them for inspection:

```
Cal. Values:  
0.234  0.245  ...
```

Press any key to continue. The calibration values can now be saved:

```
Save Calibration  
<- =NO , YES ->
```

To confirm press the  key. In this case, the calibration values are saved, and the system then goes straight to normal operation.

All other key entries skip saving and return to the beginning of the calibration function. In this case you can repeat the procedure.

Firmware update

The firmware of the fuel station can be updated online.



The update requires a JetCat USB adapter (USB to serial, Item No. 61109-10).

The update requires a Windows PC and the installation of the "JetCat ECU-V12 Updater" program.

To install the software, please enter the following line in the address bar of your Internet browser:

<http://www.cat-ing.de/jetcat-hexfiles/JetCatUpdaterV12.htm>

Then follow/enable the installation steps.

After installing the Update Utility program, follow these steps:

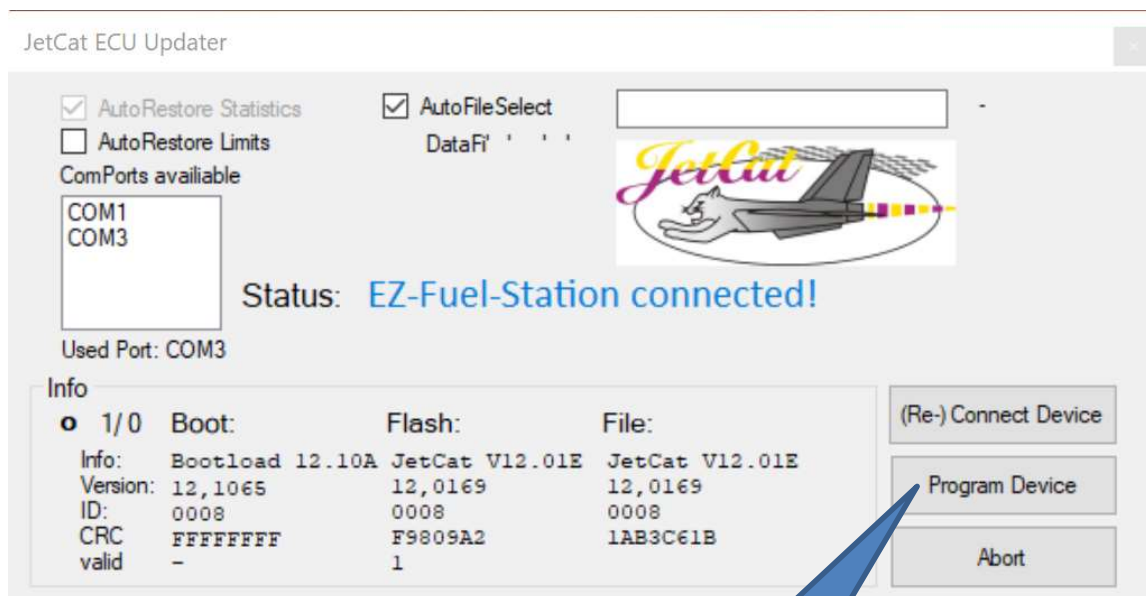

- 1) Connect the JetCat USB interface adapter to the PC and the "Exp." connection on the fuel station.
- 2) Switch on the fuel station.
- 3) Make sure the PC has a connection to the Internet!
- 4) Now start the previously installed program "**JetCat Updater-V12**" on the PC
- 5) After a few seconds, the following screen should be displayed:



Click here to start the update

Accessories

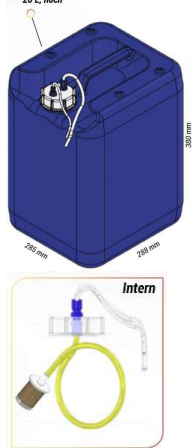
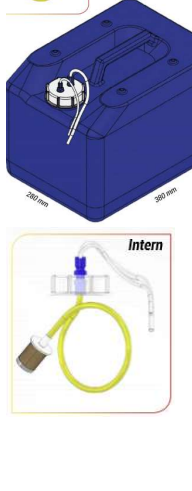
Item number	Designation	Figure
61105-65	EZ-Fueler Jet-A1	
61105-66	"Fuel" filling coupling Filling coupling for 2x6mm hose, coding "EZ-Fueler Jet-A1", anthracite/grey anodized)	
61105-67	EZ-Fueler smoke	
61105-68	Filling coupling for 2x6mm hose, coding "EZ-Fueler Smoke", red anodized)	
21105-35	Dual-fueling spiral hose	
61105-69	FuelDock	

Item number	Designation	Figure
61105-61	Fuel container (DN61), 20l, "tall" BxLxH: 285x288x380mm	
61105-62	Fuel container (DN71), 20l, "short". BxLxH: 280x380x268mm	
61105-63	<p>Scope of delivery:</p> <p>1x EZ-Fuelstation</p> <p>1x mounting bracket for fuel station (jerry can closure DN61, Ø 61 mm)</p> <p>1x mounting bracket for fuel station (jerry can closure DN71, Ø 71 mm)</p>	

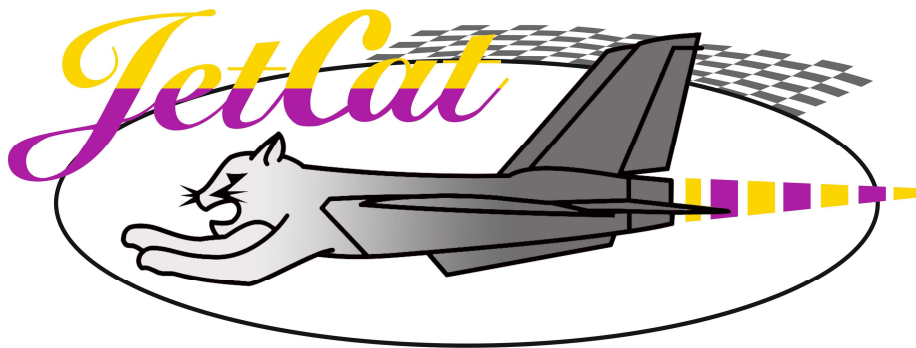

Ingenieurbüro CAT, M. Zipperer GmbH
Wettelbrunner Straße 6
D-79282 Ballrechten-Dottingen
Germany

Tel: + 49 (0) 76 34-5056-800

Fax: + 49 (0) 76 34-5056-801

Info@cat-ing.de

www.jetcat.de